



**NAVAL
POSTGRADUATE
SCHOOL**

MONTEREY, CALIFORNIA

THESIS

**GENERIC UAV MODELING TO OBTAIN ITS
AERODYNAMIC AND CONTROL DERIVATIVES**

by

Choon Seong, Chua

December 2008

Thesis Advisor:

Anthony J. Healey

Co-Advisor:

Oleg A. Yakimenko

Approved for public release; distribution is unlimited

THIS PAGE INTENTIONALLY LEFT BLANK

REPORT DOCUMENTATION PAGE			<i>Form Approved OMB No. 0704-0188</i>
Public reporting burden for this collection of information is estimated to average 1 hour per response, including the time for reviewing instruction, searching existing data sources, gathering and maintaining the data needed, and completing and reviewing the collection of information. Send comments regarding this burden estimate or any other aspect of this collection of information, including suggestions for reducing this burden, to Washington headquarters Services, Directorate for Information Operations and Reports, 1215 Jefferson Davis Highway, Suite 1204, Arlington, VA 22202-4302, and to the Office of Management and Budget, Paperwork Reduction Project (0704-0188) Washington DC 20503.			
1. AGENCY USE ONLY (Leave blank)	2. REPORT DATE December 2008	3. REPORT TYPE AND DATES COVERED Master's Thesis	
4. TITLE AND SUBTITLE Generic Uav Modeling to Obtain Its Aerodynamic and Control Derivatives		5. FUNDING NUMBERS	
6. AUTHOR(S) Choon Seong, Chua			
7. PERFORMING ORGANIZATION NAME(S) AND ADDRESS(ES) Naval Postgraduate School Monterey, CA 93943-5000		8. PERFORMING ORGANIZATION REPORT NUMBER	
9. SPONSORING /MONITORING AGENCY NAME(S) AND ADDRESS(ES) N/A		10. SPONSORING/MONITORING AGENCY REPORT NUMBER	
11. SUPPLEMENTARY NOTES The views expressed in this thesis are those of the author and do not reflect the official policy or position of the Department of Defense or the U.S. Government.			
12a. DISTRIBUTION / AVAILABILITY STATEMENT Approved for public release; distribution is unlimited		12b. DISTRIBUTION CODE	
13. ABSTRACT (maximum 200 words) <p>This thesis deals with two different software packages to obtain the aerodynamic and control derivatives for a generic unmanned air vehicle (UAV). These data has a dual application. Firstly, it is required in the Mathworks' Simulink 6-degree-of-freedom model of a generic unmanned air vehicle to develop a robust controller and do a variety of trade-offs. Secondly, is also needed to tune the parameters of the existing real-time controllers such as a Piccolo autopilot.</p> <p>The first approach explored in this thesis involves using the LinAir software program developed about a decade ago at Stanford University, the second one relies on the Athena Vortex Lattice package developed at Massachusetts Institute of Technology. The thesis applies two aforementioned packages to generate the aerodynamic data for two different-size UAVs, SIG Rascal and Thorpe Seep P10B, emphasizing advantages and pitfalls of each approach, and further compares the obtained data with that of some other UAVs such as BAI Aerosystems Tern and Advanced Ceramics Corp. Silver Fox. The thesis ends with some computer simulations based on the obtained aerodynamic data.</p>			
14. SUBJECT TERMS LinAir, Aerodynamics and Control Derivatives, Athena Vortex Lattice, Rascal, P10B, 6DOF, 6-degree-of-freedom			15. NUMBER OF PAGES 123
			16. PRICE CODE
17. SECURITY CLASSIFICATION OF REPORT Unclassified	18. SECURITY CLASSIFICATION OF THIS PAGE Unclassified	19. SECURITY CLASSIFICATION OF ABSTRACT Unclassified	20. LIMITATION OF ABSTRACT UU

THIS PAGE INTENTIONALLY LEFT BLANK

Approved for public release; distribution is unlimited

**GENERIC UAV MODELING TO OBTAIN ITS AERODYNAMIC AND
CONTROL DERIVATIVES**

Choon Seong, Chua
ST Aerospace Limited, Singapore
B. Engineering (ME), Nanyang Technological University, Singapore, 1999

Submitted in partial fulfillment of the
requirements for the degree of

MASTER OF SCIENCE IN MECHANICAL ENGINEERING

from the

**NAVAL POSTGRADUATE SCHOOL
December 2008**

Author: Choon Seong, Chua

Approved by: Prof. Anthony J. Healey
Thesis Advisor

Professor Oleg A. Yakimenko
Co-Advisor

Professor Knox T. Millsaps
Chairman, Department of Mechanical and Astronautical
Engineering

THIS PAGE INTENTIONALLY LEFT BLANK

ABSTRACT

This thesis deals with two different software packages to obtain the aerodynamic and control derivatives for a generic unmanned air vehicle (UAV). These data has a dual application. Firstly, it is required in the Mathworks' Simulink 6-degree-of-freedom model of a generic unmanned air vehicle to develop a robust controller and do a variety of trade-offs. Secondly, is also needed to tune the parameters of the existing real-time controllers such as a Piccolo autopilot.

The first approach explored in this thesis involves using the LinAir software program developed about a decade ago at Stanford University, the second one relies on the Athena Vortex Lattice package developed at Massachusetts Institute of Technology. The thesis applies two aforementioned packages to generate the aerodynamic data for two different-size UAVs, SIG Rascal and Thorpe Seeop P10B, emphasizing advantages and pitfalls of each approach, and further compares the obtained data with that of some other UAVs such as BAI Aerosystems Tern and Advanced Ceramics Corp. Silver Fox. The thesis ends with some computer simulations based on the obtained aerodynamic data.

THIS PAGE INTENTIONALLY LEFT BLANK

TABLE OF CONTENTS

I.	INTRODUCTION.....	1
A.	BACKGROUND	1
B.	OBJECTIVES	4
1.	LinAir.....	4
2.	Athena Vortex Lattice (AVL)	4
C.	REPORT STRUCTURE	4
II.	MODELING OF P-10B UAV	7
A.	BACKGROUND	7
B.	GEOMETRY.....	8
C.	MS EXCEL MODEL.....	10
D.	LINAIR MODEL	11
E.	AVL MODEL	28
III.	MODELING OF RASCAL UAV	33
A.	BACKGROUND	33
B.	GEOMETRY.....	33
C.	MS EXCEL MODEL.....	37
D.	LINAIR MODEL	37
E.	AVL MODEL	41
IV.	SIMULINK MODEL.....	45
A.	MOMENT OF INERTIA	45
B.	P10B SIMULATION RESULTS	46
1.	Trim condition.....	46
2.	Change in Thrust Parameter	48
3.	Change in Elevator Deflection	48
4.	Change in Aileron Deflection.....	49
5.	Change in Rudder Deflection.....	50
C.	RASCAL SIMULATION RESULTS.....	51
1.	Trim Condition.....	51
2.	Change in Thrust Parameter	53
3.	Change in Elevator Deflection	53
4.	Change in Aileron Deflection.....	54
5.	Change in Rudder Deflection.....	55
V.	DISCUSSION AND CONCLUSION	57
A.	LINAIR LIMITATIONS AND CONSTRAINTS	57
B.	AVL LIMITATIONS AND CONSTRAINTS	58
C.	CONCLUSION	59
VI.	RECOMMENDATION.....	61
A.	AVL	61
B.	VERIFICATION WITH ACTUAL DATA	61
C.	FUTURE WORK ON P10B AND RASCAL.....	61

APPENDIX A. MATLAB SIMULINK INPUT FILE	63
A. P-10B SIMULINK MODEL INPUT FILE.....	63
B. RASCAL SIMULINK MODEL INPUT FILE.....	64
APPENDIX B GRAPHICAL UAV MODELS.....	67
A. P-10B MODEL	67
B. RASCAL MODEL	68
APPENDIX C: LINAIR INPUT MODEL.....	71
A. P-10B LINAIR INPUT MODEL	71
B. RASCAL LINAIR MODEL.....	76
APPENDIX D: SIMULINK TRIM COMMAND.....	83
APPENDIX E: AVL INPUT FORMAT	85
APPENDIX F: AVL INPUT FILE.....	89
A. P-10B MODEL	89
B. RASCAL MODEL	98
LIST OF REFERENCES.....	105
INITIAL DISTRIBUTION LIST	107

LIST OF FIGURES

Figure 1.	In-house UAV Matlab Simulink Model	2
Figure 2.	Piccolo II (CCT Part No. 900-90010-00)	2
Figure 3.	Thorpe Seeop P-10B (From [3])	7
Figure 4.	Clark Y Airfoil Chart (From [6])	10
Figure 5.	P-10B LinAir Model	12
Figure 6.	Force contribution of entire P-10B model	13
Figure 7.	P-10B LinAir Alpha vs. Lift coefficient curve	14
Figure 8.	P-10B LinAir Drag coefficient vs. Lift Coefficient curve	15
Figure 9.	Curve for CL_0 and CL_{α}	16
Figure 10.	Curve for CL_q	17
Figure 11.	Curve for CL_{De}	17
Figure 12.	Curve for CD_0 , A_1 and A_2	18
Figure 13.	Curve for CD_{De}	19
Figure 14.	Curve for C_{Yb}	19
Figure 15.	Curve for C_{YDr}	20
Figure 16.	Curve for C_{lb}	20
Figure 17.	Curve for C_{lp}	21
Figure 18.	Curve for C_{lr}	21
Figure 19.	Curve for C_{lDa}	22
Figure 20.	Curve for C_{lDr}	23
Figure 21.	Curve for CM_0 and CM_{α}	23
Figure 22.	Curve for CM_q	24
Figure 23.	Curve for CM_{De}	25
Figure 24.	Curve for C_{Nb}	25
Figure 25.	Curve for C_{Np}	26
Figure 26.	Curve for C_{Nr}	26
Figure 27.	Curve for C_{NDa}	27
Figure 28.	Curve for C_{NDr}	27
Figure 29.	AVL GUI to create fuselage	29
Figure 30.	AVL Airfoil Editor	29
Figure 31.	AVL NACA Clark Y Airfoil Profile Input	30
Figure 32.	AVL GUI for surface editor	31
Figure 33.	P-10B Model in AVL	32
Figure 34.	Cross sectional view of NACA 2312 airfoil[9]	34
Figure 35.	NACA 2312 Drag Coefficient vs. Mach [10]	35
Figure 36.	NACA 2312 airfoil in AVL	36
Figure 37.	CD vs. CL for NACA 2312 using AVL	36
Figure 38.	Rascal LinAir model	38
Figure 39.	Force contribution along Y axis for Rascal LinAir Model	38
Figure 40.	Lift coefficient vs. AOA for Rascal LinAir model	39
Figure 41.	Drag coefficient vs. lift coefficient for Rascal LinAir model	40
Figure 42.	Rascal Model in AVL	42

Figure 43.	P10B longitudinal channel at trim condition	47
Figure 44.	P10B lateral channel at trim condition.....	47
Figure 45.	P10B longitudinal channel with 22% (10N) throttle increase	48
Figure 46.	P10B longitudinal channel with 1 degree elevator deflection	49
Figure 47.	. P10B lateral channel with 1 degree aileron deflection	50
Figure 48.	. P10B lateral channel with 1 degree rudder deflection.....	51
Figure 49.	Rascal longitudinal channel at trim condition	52
Figure 50.	.Rascal lateral channel at trim condition.....	52
Figure 51.	Rascal longitudinal channel with 21% (1N) throttle increase	53
Figure 52.	Rascal longitudinal channel with -1 degree elevator deflection	54
Figure 53.	.Rascal lateral channel with 0.1 degree aileron deflection.....	55
Figure 54.	.Rascal lateral channel with 0.1 degree rudder deflection	56
Figure 55.	P-10B Model.....	67
Figure 56.	MS Visio model for Fuselage	68
Figure 57.	MS Visio model for Wing and Aileron.....	68
Figure 58.	MS Visio model for horizontal stabilizer and Elevator	69
Figure 59.	MS Visio model for Vertical Stabilizer and Rudder.....	69

LIST OF TABLES

Table 1.	Non-dimensional aerodynamic and control derivatives for several UAVs (From [1]).	3
Table 2.	Consolidation of P-10B coefficient Using LinAir (After [1])	28
Table 3.	Consolidation of Rascal coefficients using LinAir (After [1])	41
Table 4.	Consolidation of Rascal coefficients using AVL (After [1])	43
Table 5.	Moment of inertia for P10B(After [1])	45
Table 6.	Aerodynamic model parameter at trim condition	46

THIS PAGE INTENTIONALLY LEFT BLANK

ACKNOWLEDGMENTS

Firstly I would like to thank Professor Anthony J. Healey for giving me the opportunity to work on a UAV thesis. I would also like to express my gratitude to Professor Oleg A. Yakimenko for his time and effort during the entire research process. I would also like to thank Professor Kevin Jones for providing the geometry data for Rascal UAV. Lastly but not least, I would like to thank my wife, Bee Hwa Lim, for her understanding and support during the course of the research.

THIS PAGE INTENTIONALLY LEFT BLANK

I. INTRODUCTION

A. BACKGROUND

UAV modeling has been part of the design and modification process for new UAVs and has increasingly been used for rapid testing and verification. Changes and modifications are made to the model, evaluating it for intended function against the requirement. Modeling allows a faster verification and iteration of the design change cycle without having to conduct a flight test with a prototype UAV. It also reduces the cost incurred for each design change.

At the Naval Postgraduate School's Center for Autonomous Unmanned Vehicle Research, the two types of UAV simulations most widely used are the Matlab Simulink UAV model and the Piccolo Autopilot simulation.

The Matlab UAV Simulink model is a generic 6 degree of freedom (6DOF) model for UAVs. This model is adopted in many research areas for UAV modification or operation scenario simulations. Figure 1. shows the top level model of the generic UAV model.

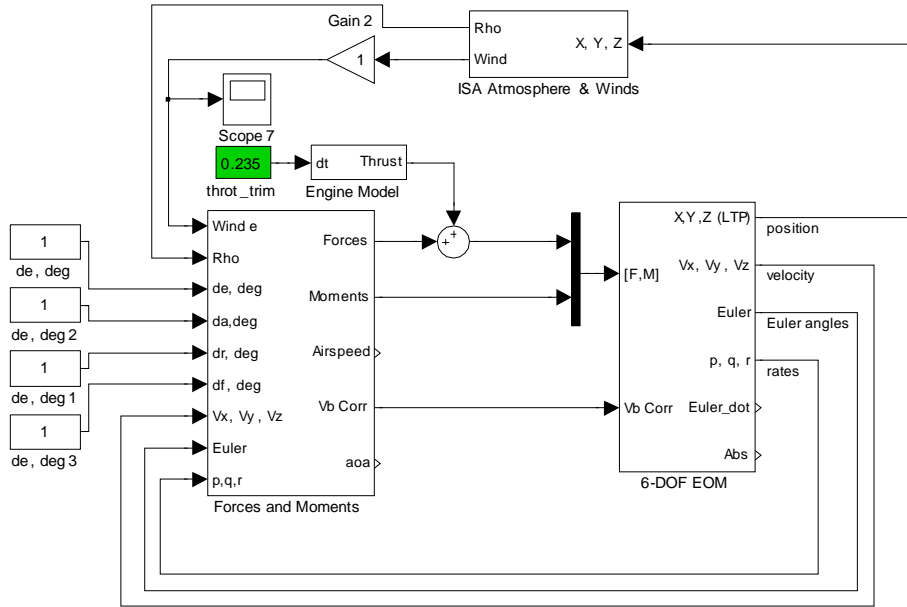

Figure 1. In-house UAV Matlab Simulink Model

The test-beds used most often by the Center for Autonomous Unmanned Vehicle Research is the Rascal UAV, which uses the Piccolo Autopilot module. This autopilot module comes with a Piccolo simulator that allows the software to perform offline simulations.



Figure 2. Piccolo II (CCT Part No. 900-90010-00)

UAV aerodynamic derivatives are required for both the UAV Matlab Simulink model and the Piccolo Autopilot simulator. UAV derivatives constitute a large portion of

the input file for the Matlab Simulink 6DOF model, as shown in Appendix A. The same derivatives are required for the Piccolo Autopilot simulator.

Various research projects have been carried out to determine the aerodynamic properties of the UAV. Figure 1. shows an extract of some UAV aerodynamic properties [1].

			Pioneer ²⁶	Bluebird ³⁰	FROG ³¹	Old Silver Fox	New Silver Fox	
			<i>Analytical approach</i>			<i>Panel code</i>		
C_{L0}	CL0	<i>lift coefficient at $\alpha = 0$</i>	0.385	0.02345	0.4295	0.3260	0.3280	0.3243
$C_{L\alpha}$	CLalpha	<i>lift curve slope</i>	4.78	4.1417	4.3034	4.6800	5.0970	6.0204
$C_{L\dot{\alpha}}$	CLa_dot	<i>lift due to angle of attack rate</i>	2.42	1.5787	1.3877	0.8610	1.9300	1.9300
$C_{L\dot{q}}$	CLq	<i>lift due to pitch rate</i>	8.05	3.9173	3.35	2.5300	6.0300	6.0713
$C_{L\delta_e}$	CLDe	<i>lift due to elevator</i>	0.401	0.4130	0.3914	0.3510	0.7380	0.9128
C_{D0}	CD0	<i>drag coefficient at $C_L = 0$</i>	0.06	0.0311	0.0499	0.0187	0.0191	0.0251
A_1	A1	<i>drag curve coefficient at C_L</i>	0.43	0.1370	0.23	0.0000	0.0000	-0.0241
A_2	A2	<i>drag curve coefficient at C_L^2</i>				0.0413	0.0377	0.0692
$C_{D\delta_e}$	CDDe	<i>drag due to elevator</i>	0.018	0.0650	0.00676	0.0486	0.1040	0.1000
$C_{Y\beta}$	CYb	<i>side force due to sideslip</i>	-0.819	-0.3100	-0.3100	-0.3100	-0.2040	-0.3928
$C_{Y\delta_r}$	CYDr	<i>side force due to rudder</i>	0.191	0.0697	0.0926	0.0613	0.1120	0.1982
$C_{l\delta_r}$	Clb	<i>dihedral effect</i>	-0.023	-0.0330	-0.0509	-0.0173	-0.0598	-0.0113
$C_{\dot{p}}$	Clp	<i>roll damping</i>	-0.45	-0.3579	-0.3702	-0.3630	-0.3630	-1.2217
$C_{\dot{r}}$	Clr	<i>roll due to yaw rate</i>	0.265	0.0755	0.1119	0.0839	0.0886	0.0150
$C_{l\delta_a}$	ClDa	<i>roll control power</i>	0.161	0.2652	0.1810	0.2650	0.2650	0.3436
$C_{l\delta_r}$	ClDr	<i>roll due to rudder</i>	-0.00229	0.0028	0.0036	0.0027	0.0064	0.0076
C_{m0}	Cm0	<i>pitch moment at $a = 0$</i>	0.194	0.0364	0.051	0.0438	0.0080	0.0272
$C_{m\alpha}$	Cma	<i>pitch moment due to angle of attack</i>	-2.12	-1.0636	-0.5565	-0.8360	-2.0510	-1.9554
$C_{m\dot{\alpha}}$	Cma_dot	<i>pitch moment due to angle of attack rate</i>	-11	-4.6790	-3.7115	-2.0900	-5.2860	-5.2860
$C_{m\dot{q}}$	Cmq	<i>pitch moment due to pitch rate</i>	-36.6	-11.6918	-8.8818	-6.1300	-16.5200	-9.5805
$C_{m\delta_e}$	CmDe	<i>pitch control power</i>	-1.76	-1.2242	-1.0469	-0.8490	-2.0210	-2.4808
$C_{n\beta}$	Cnb	<i>weathercock stability</i>	0.109	0.0484	0.0575	0.0278	0.0562	0.0804
$C_{n\dot{p}}$	Cnp	<i>adverse yaw</i>	-0.11	-0.0358	-0.0537	-0.0407	-0.0407	-0.0557
$C_{n\dot{r}}$	Cnr	<i>yaw damping</i>	-0.2	-0.0526	-0.0669	-0.0232	-0.0439	-0.1422
$C_{n\delta_a}$	CnDa	<i>aileron adverse yaw</i>	-0.02	-0.0258	-0.0272	-0.0294	-0.0296	-0.0165
$C_{n\delta_r}$	CnDr	<i>yaw control power</i>	-0.0917	-0.0326	-0.0388	-0.0186	-0.0377	-0.0598

Table 1. Non-dimensional aerodynamic and control derivatives for several UAVs (From [1].)

B. OBJECTIVES

The objective of this thesis is to determine the aerodynamics derivative using two software tools, LinAir and Athena Vortex Lattice (AVL).

1. LinAir

LinAir is a program that computes aerodynamic properties based on the model created. It is capable of generating the effect of angle of attack (AOA) and side slip angle on the force, drag coefficient, lift coefficient, etc.

LinAir was developed first in 1982 and has been modified over the following years for various applications. It has been run on computers ranging from small laptops to VAXes and Crays. LinAir is now used in courses at several universities, by companies such as Boeing, AeroVironment, Northrop, and Lockheed, and by researchers at NASA to obtain a quick look at new design concepts [2].

2. Athena Vortex Lattice (AVL)

Athena Vortex Lattice (AVL) is the other software program that was evaluated to compute the Rascal UAV aerodynamics derivative. AVL is a freeware created by Prof. Mark Drela of MIT. However, AVL alone is similar to LinAir, using a test file as the input source. It is possible to format and export the Rascal model in MS Excel for input into the AVL.

However, the program AVL Editor, created by CloudCap Technology, serves as the graphic user interface to provide a window-based editor with manual coordinate input windows. The AVL Editor is able to provide visual inspection of the model created. The AVL software together with the AVL Editor can be found at http://www.cloudcaptech.com/resources_autopilots.shtm#downloads.

C. REPORT STRUCTURE

Section II discusses the modeling process of the P-10B model including LinAir and AVL. Section III presents the Rascal model including LinAir and AVL. Section IV

presents the results of simulink model responses to the data of LinAir and AVL. Section V reviews the limitation and constraints of LinAir and AVL, follow by conclusions. Finally, Section VI recommends directions for possible future research.

THIS PAGE INTENTIONALLY LEFT BLANK

II. MODELING OF P-10B UAV

A. BACKGROUND

The Thorpe Seeop P-10B is a Remotely Piloted Testbed (RPT), pictured in Figure 3. An upcoming research program is planned for this UAV, and this thesis, which determines the aerodynamics derivative, has laid the groundwork for the future research work.



Figure 3. Thorpe Seeop P-10B (From [3])

The base model from Thorpe Seeop Corporation is configurable to meet various needs of operation. Following is the specification of a configuration that will be modeled. [3]

- Model: Thorpe Seeop P-10B (<http://www.seeop.com/>)
- Wingspan: 21.25 feet
- Engine: 22 HP, two-cylinder, two-stroke
- Fuel cap: 3 US gal
- Max endurance: 2 hrs
- Speed: 70 mph
- Empty wt: 160 lbs
- Max takeoff w: 250 lbs

- G limits: +3, -1.0 g's
- Payload weight: 50 to 85 lbs
- Payload volume: 11 x 11 x 23 inches
- Runway requirement: 400 ft minimum for landing, 300 ft for takeoff

B. GEOMETRY

The graphical model of this UAV is provided in Appendix B. The airframe has a center of gravity at 7.5" from the leading edge of the wings, along the X axis, and from the center of the fuselage height.

This UAV uses a Clark Y airfoil for the wing and a NACA 0008 for its horizontal stabilizer and vertical stabilizer. The Clark Y airfoil is a general airfoil that is widely used, and its profile can be found at http://www.ae.uiuc.edu/m-selig/ads/coord_database.html.

The profile was designed in 1922 by Virginus E. Clark. The airfoil has a thickness of 11.7 percent and is flat on the lower surface from 30 percent of chord back. The flat bottom simplifies angle measurements on propellers, and makes for easy construction of wings on a flat surface[4]. The airfoil profile data in Appendix E could be imported into the AVL easily for modeling.

With the airfoil identified, the drag coefficient of the airfoil that consists of the following 2 portions can be identified.

1. $C_{D_{min}}/ C_{D_0}$ - minimum drag that is achievable when the airfoil is in zero angle of attack (AOA).
2. C_{Di} – induced drag as a result of increasing AOA and velocity of the airfoil.

A typical drag coefficient model consists of C_{D0} , C_{D1} and C_{D2} .

$$C_D = C_{D0} + A_1 C_L + A_2 C_L^2$$

These are also the input values for the LinAir model, matching the following modern drag equation from NASA [5]

$$C_D = C_{D,\min} + (\pi \times AR \times \varepsilon) C_L^2$$

$$AR = \text{WingSpan}^2 / \text{WingArea}$$

$$\varepsilon = \text{efficiency} = 0.9$$

Therefore

$$C_{D0} = C_{D,\min}$$

$$A_2 = \frac{1}{\pi \times AR \times \varepsilon}$$

$$AR = \frac{254^2}{7620} = 8.467$$

Assuming $\varepsilon=0.9$

$$A_2 = \frac{1}{\pi \times 8.467 \times 0.9} = 0.04177$$

From the above calculation, $A_2 = 0.04177$. C_{D0} is found to be about 0.01 based on Figure 4.

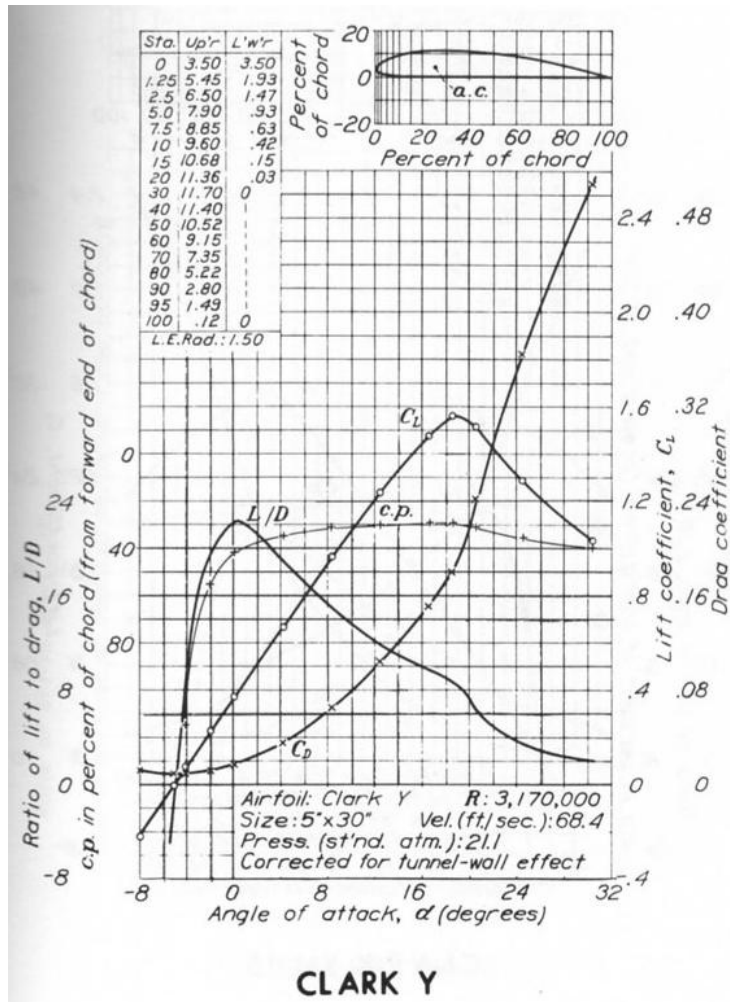

Figure 4. Clark Y Airfoil Chart (From [6])

C. MS EXCEL MODEL

Data from the geometry of the UAV is used to create the MS Excel model. English units were adopted for the model, but it should be noted that the LinAir model is independent of units as long as the units are consistent within the model. A basic model was created with 22 elements that consist of the following:

- o 3 elements for vertical fuselage
- o 3 elements for horizontal fuselage
- o 2 elements for left wing

- o 2 elements for right wing
- o 1 element for left aileron
- o 1 element for right aileron
- o 2 elements for horizontal stabilizer
- o 2 elements for left elevator
- o 2 elements for right elevator
- o 2 elements for vertical stabilizer
- o 2 elements for rudder

The reference area (S_{ref}) is the projected wings area on the X-Y plane, is computed to be 7620 square inches. From the geometry model, the reference wing span (B_{ref}) is determined to be 254 inches. Once the base model is completed, it is modified to adjust the coordination of the control surfaces (aileron, elevator, and rudder) with the input of angle of deflection.

D. LINAIR MODEL

Verification of the model is performed by exporting the model into a test file (space delimited format) and loading it with LinAir to check for visual error. Figure 5. shows the P-10B LinAir model; for the P-10B LinAir model input file, refer to Appendix C.

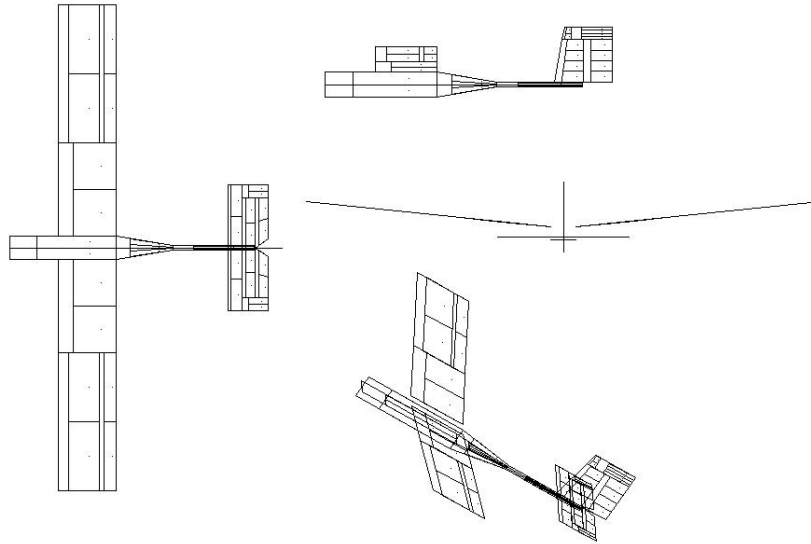

Figure 5. P-10B LinAir Model

Once the model is completed, it is run for Alpha range from -10° to 15° in steps of 1° increments. Figure 6. shows the force contribution of each element and panel of the entire model. Most of the force contribution must be positive, especially for the wings, as it is the main lift contribution for the entire airframe. For a symmetrical airframe, the force contribution should be symmetrical as well. The only time it is asymmetric is when the aileron control surface is deflected, and the left side deflection is opposite to the right side.

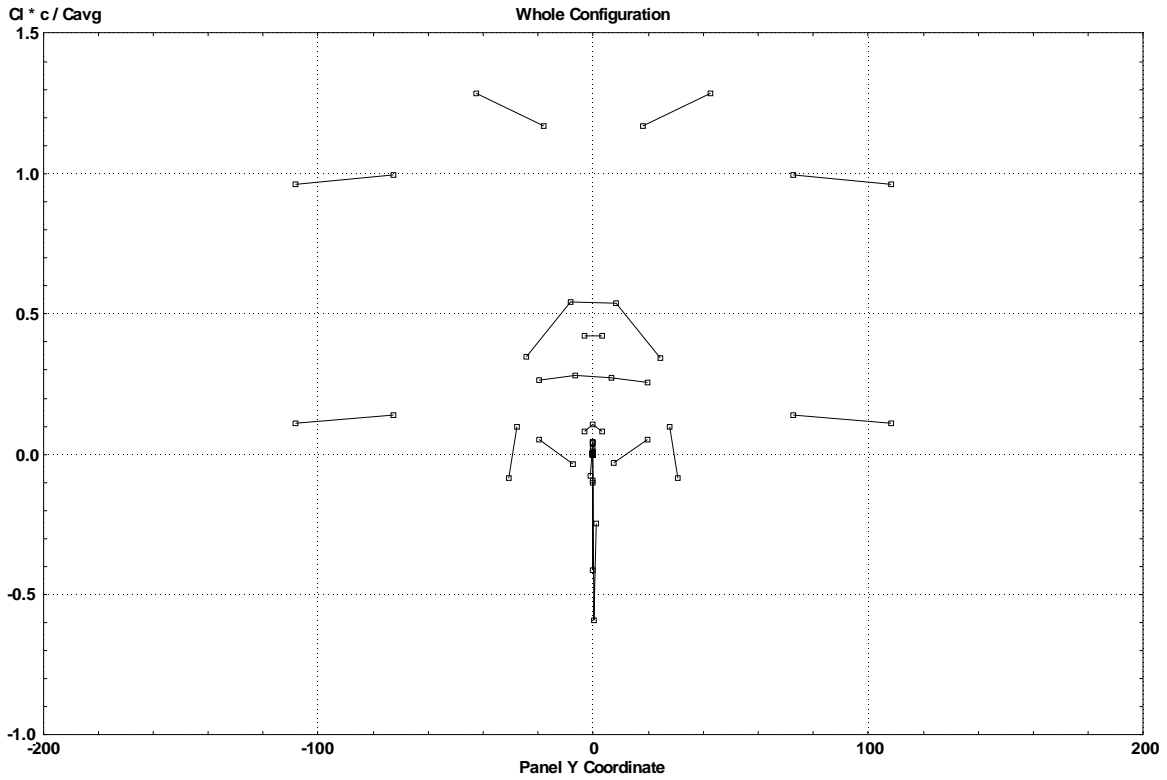

Figure 6. Force contribution of entire P-10B model

The next property to check is the relationship of Alpha (AOA) against lift coefficient (CL), as shown in Figure 7. The curve must have a positive gradient such that CL increases as AOA increases.

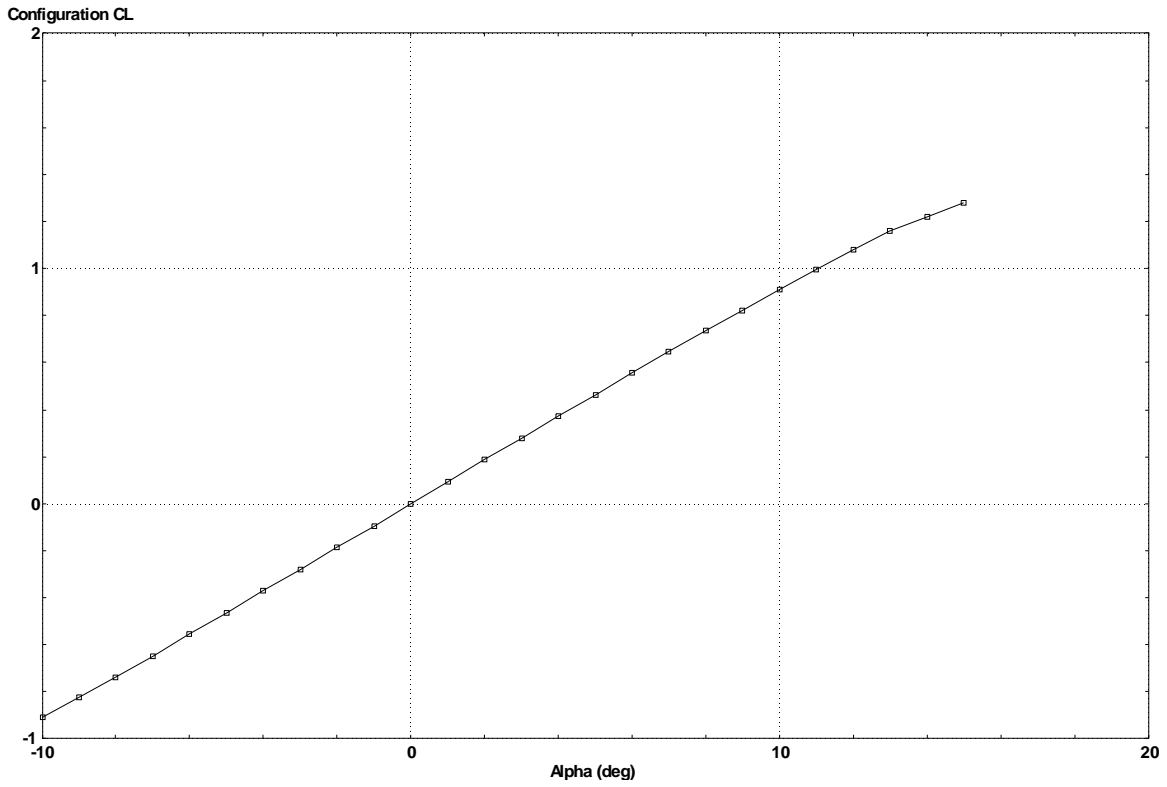

Figure 7. P-10B LinAir Alpha vs. Lift coefficient curve

The third check will be the drag coefficient (CD) vs. lift coefficient (CL). Figure 8. shows a typical CD vs. CL polynomial curve.

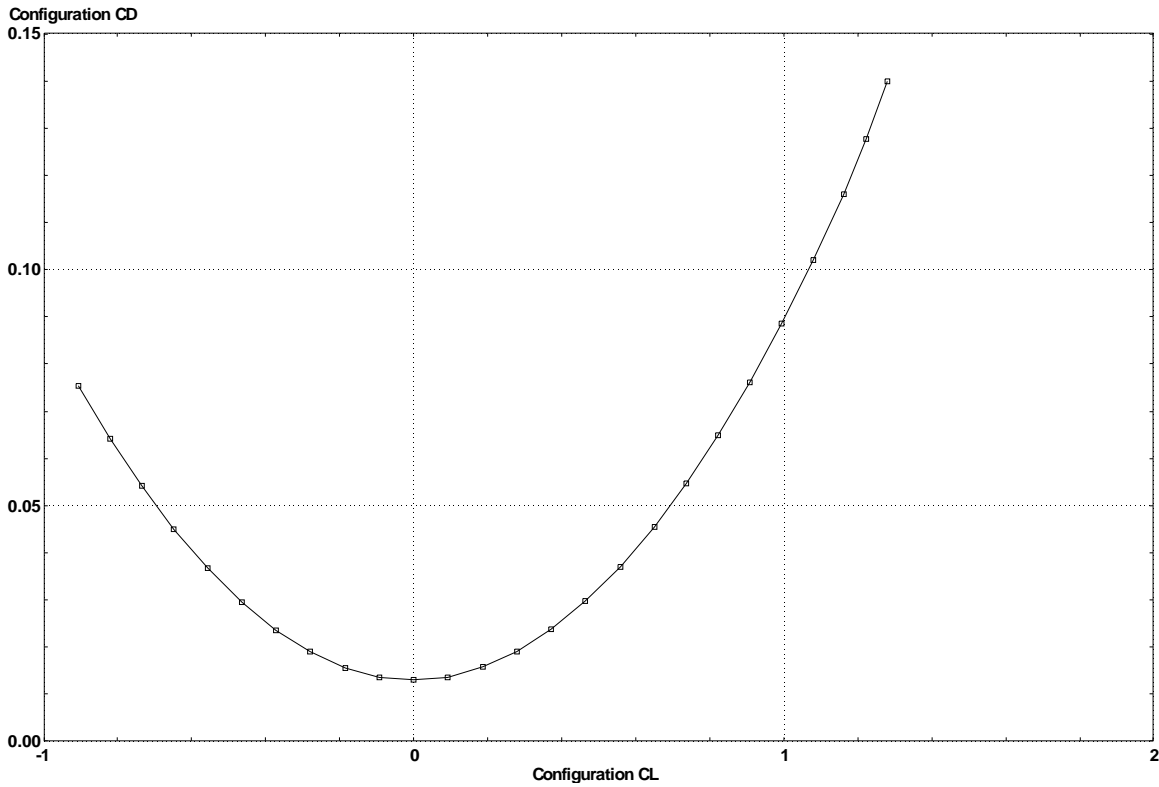

Figure 8. P-10B LinAir Drag coefficient vs. Lift Coefficient curve

Once all the checks were completed, the following runs were performed to gather the necessary data for coefficient analysis.

1. Basic model with AOA varies from -10° to 15° and Beta varies from -10° to 15° at 1° step interval.
2. Basic model with $\text{phat} = 1 \text{ rad/s}$ and Beta varies from -10° to 15° at 1° step interval.
3. Basic model with $\text{qhat} = 1 \text{ rad/s}$ and AOA varies from -10° to 15° at 1° step interval.
4. Basic model with $\text{rhat} = 1 \text{ rad/s}$ and Beta varies from -10° to 15° at 1° step interval.
5. Deflection of Aileron for 5° , 10° , and 15° deflection and Beta varies from -10° to 15° at 1° step interval.

6. Deflection of Elevator for 5°, 10°, and 15° deflection and AOA varies from -10° to 15° at 1° step interval.
7. Deflection of Rudder for 5°, 10°, and 15° deflection and Beta varies from -10° to 15° at 1° step interval.

All data generated were imported into MS Excel for analysis, and the following coefficients were obtained.

1. CL_0 is the lift coefficient, and at alpha is zero. This is the y-intercept of the Lift coefficient (CL) vs. AOA, as shown in Figure 9.
2. CL_{α} is the gradient of the Lift coefficient (CL) vs. AOA curve. This is a positive gradient curve, as shown in Figure 9.

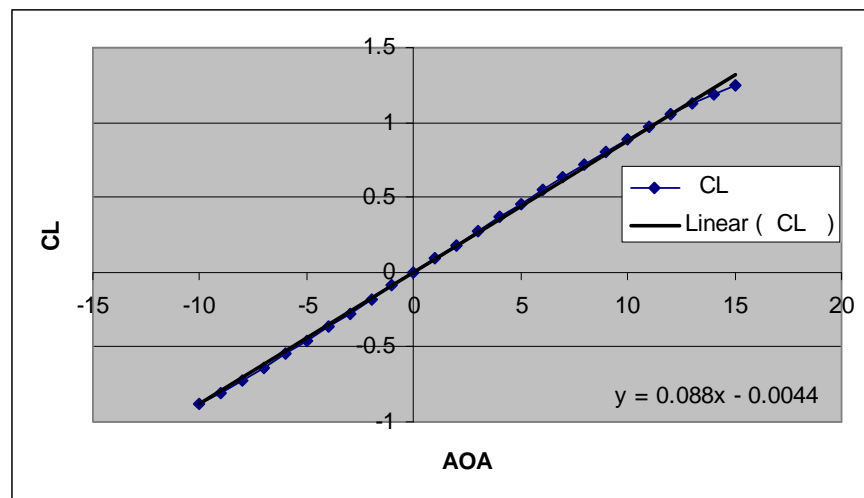

Figure 9. Curve for CL_0 and CL_{α}

3. $CL_{\dot{\alpha}}$ is the lift due to angle of attack rate. This value may be obtained by averaging the increase in lift due to AOA from -10° to 15°.
4. CL_q is the lift due to pitch rate. This is obtained by applying 1 rad/s pitch rate to the model without any control surfaces deflection. A curve of CL vs. AOA was plotted. The y-intercept is the lift due to pitch rate of the UAV, as shown in Figure 10.

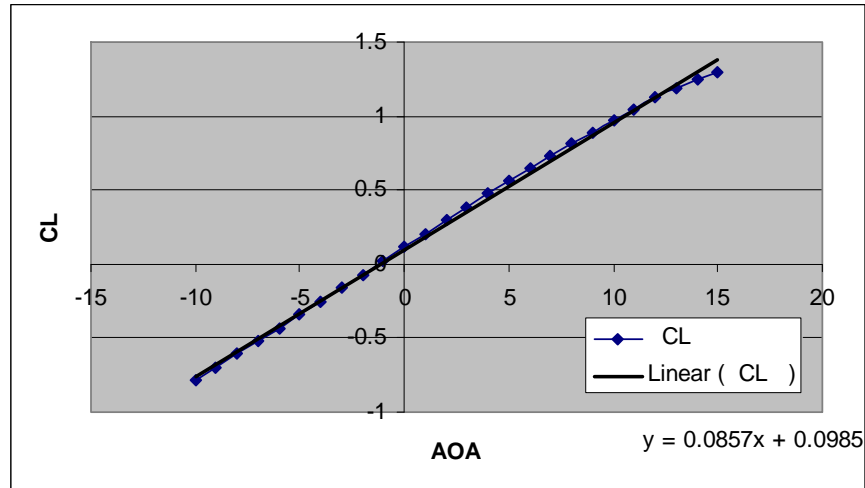

Figure 10. Curve for CLq

5. CLDe is the lift due to elevator deflection. Various elevator deflection models were simulated, at 5°, 10°, and 15°. All three curves of CL vs. AOA were plotted in the same chart, and it is worth noting that they follow almost the same gradient. Differences of the y-intercept between 0° and 15° curve were obtained and divided by 15 (since total deflection is 15°). This is the lift due to deflection of elevator per degree of deflection, as shown in Figure 11.

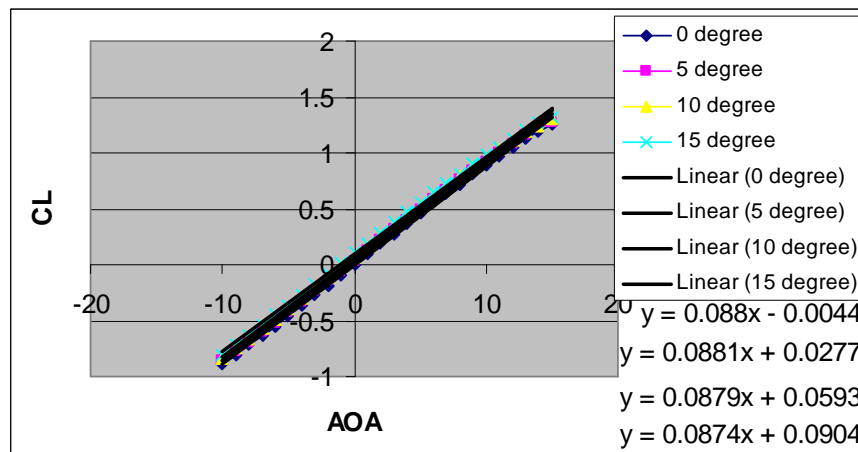

Figure 11. Curve for CLDe

6. CD_0 is the drag coefficient at $CL = 0$. This coefficient is obtained from the CD vs. CL curve, which is typically a polynomial curve. CD_0 is the minimum drag coefficient when lift coefficient (CL) is at zero value, or y-intercept, as shown in Figure 12.
7. A_1 is the drag curve coefficient at CL . This coefficient is obtained from the CD vs. CL curve. A_1 is the coefficient of first order lift coefficient, $CD = A_1 * CL^2 + A_2 * CL + CD_0$, as shown in Figure 12.
8. A_2 is the drag curve coefficient at CL^2 . This coefficient is obtained from the CD vs. CL curve. A_1 is the coefficient of second order lift coefficient, $CD = A_1 * CL^2 + A_2 * CL + CD_0$, as shown in Figure 12.

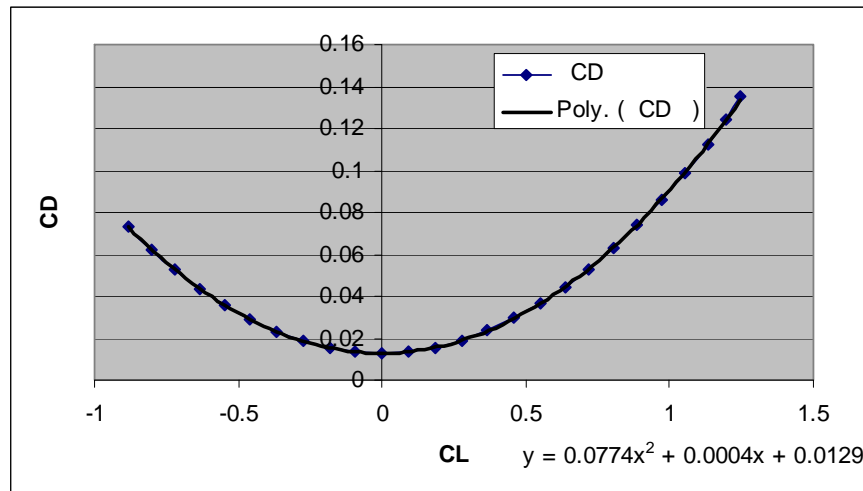

Figure 12. Curve for CD_0 , A_1 and A_2

9. $CDDe$ is the drag due to elevator deflection. Various elevator deflection models were simulated, at 5° , 10° , and 15° . All three curves of CD vs. AOA were plotted in the same chart, and once again they have almost the same gradient. Differences of the y-intercept between 0° and 15° curve were obtained and divided by 15 (since total deflection is 15°). This is the drag due to deflection of elevator per degree of deflection, as shown in Figure 13.

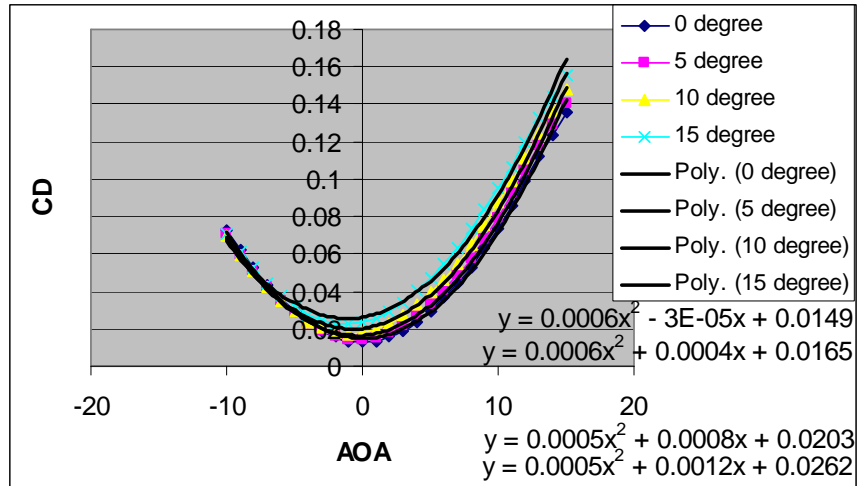

Figure 13. Curve for CDDe

10. CY_b is the side force due to sideslip. This coefficient can be obtained from the gradient of the CY vs. Beta curve. Typically the y-intercept is zero if the model is stable and no side force is expected for zero side slip, as shown in Figure 14.

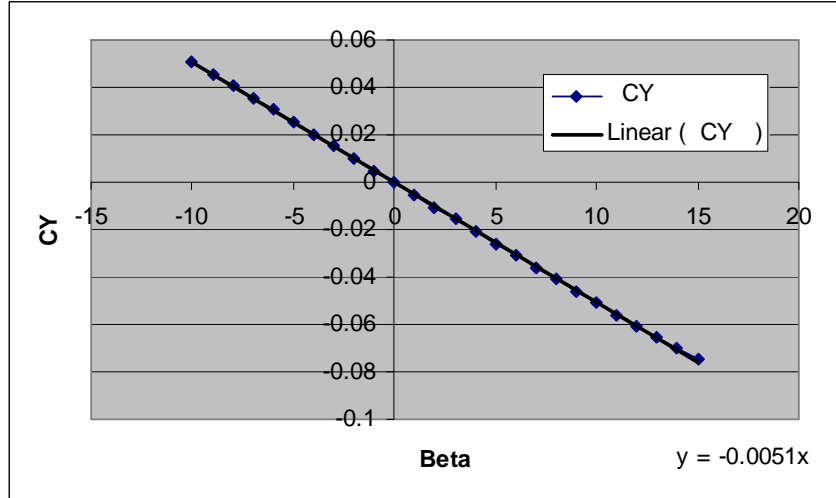

Figure 14. Curve for CY_b

11. CY_{Dr} is the side force due to rudder deflection. Various rudder deflection models were simulated, at 5° , 10° , and 15° . All three curves of CY vs. Beta were plotted in the same chart and follow almost the same gradient.

Differences of the y-intercept between 0° and 15° curves were obtained and divided by 15 (since total deflection is 15°). The value obtained is the side force due to one degree of rudder deflection, as shown in Figure 15.

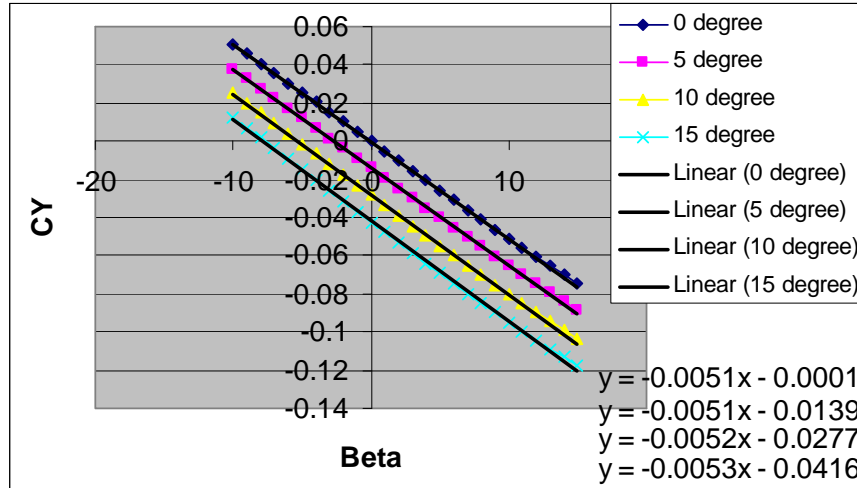

Figure 15. Curve for CYDr

12. Clb is the dihedral effect. The dihedral effect coefficient could be obtained from the gradient of the CR vs. Beta curve. Typically this curve has zero y-intercept, as shown in Figure 16.

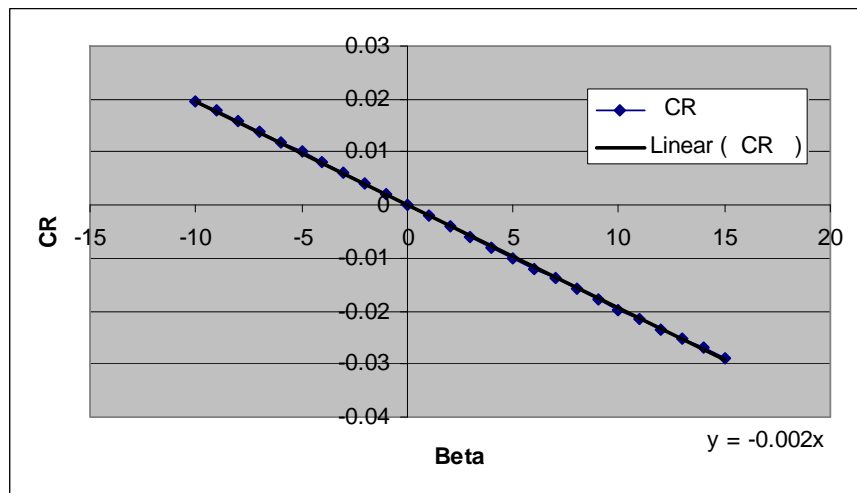

Figure 16. Curve for Clb

13. Cl_p is the roll damping. Roll damping is the roll effect of the UAV as a result of applying 1 rad/s roll rate without any control surfaces deflection. A polynomial curve of CR vs. Beta was plotted. The y-intercept is the Roll damping of the UAV, as shown in Figure 17.

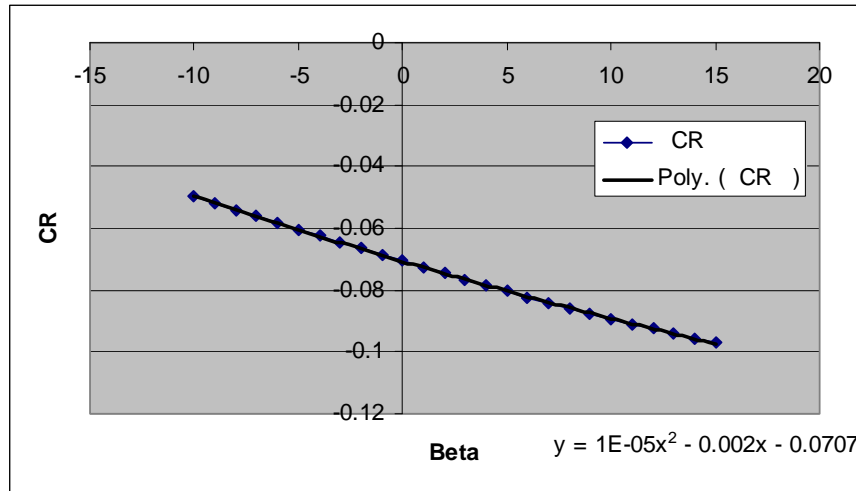

Figure 17. Curve for Cl_p

14. Cl_r is the roll due to yaw rate. This is obtained by applying 1 rad/s yaw rate and without any control surfaces deflection. A curve of CR vs. Beta was plotted. The y-intercept is the Roll damping of the UAV, as shown in Figure 18.

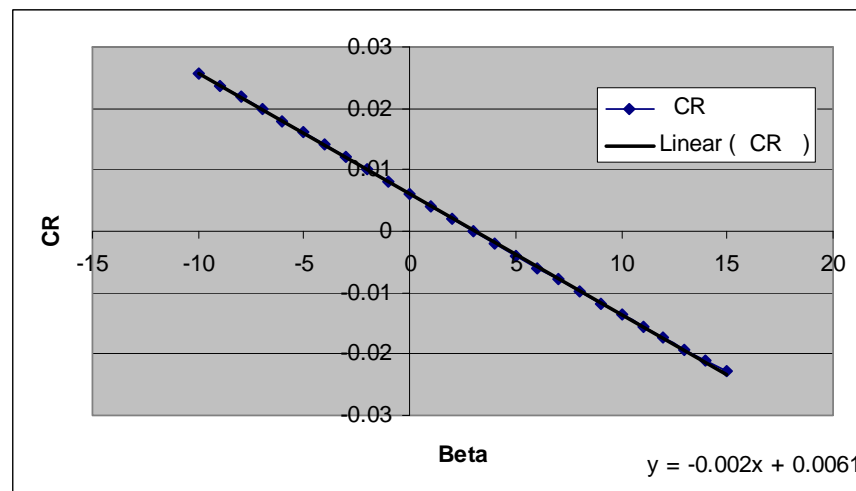

Figure 18. Curve for Cl_r

15. CIDa is the roll control power due to aileron deflection. Various aileron deflection models were simulated, at 5°, 10°, and 15°. All three curves of CR vs. Beta were plotted in the same chart and follow almost the same gradient. Differences of the y-intercept between 0° and 15° curves were obtained and divided by 15 (since total deflection is 15°). The value obtained is the side roll rate due to one degree of aileron deflection, as shown in Figure 19.

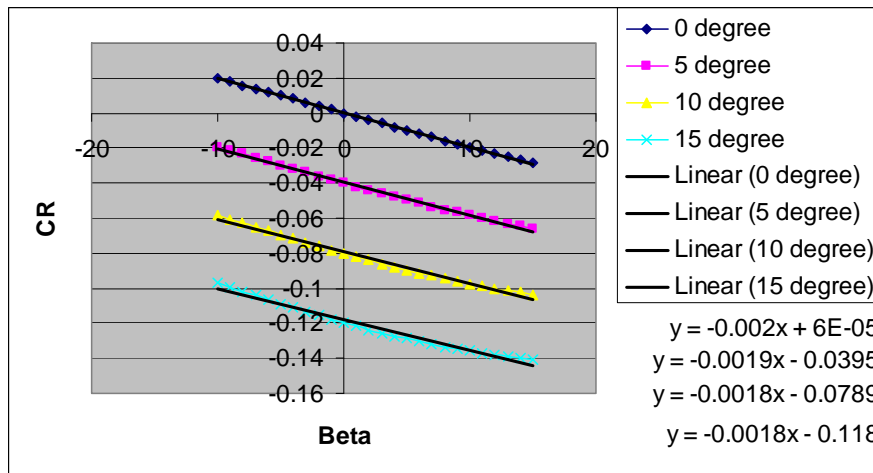

Figure 19. Curve for CIDa

16. CIDr is the roll due to rudder deflection. Various rudder deflection models were simulated, at 5°, 10°, and 15°. All three curves of CR vs. Beta were plotted in the same chart and follow almost the same gradient. Differences of the y-intercept between 0° and 15° curves were obtained and divided by 15 (since total deflection is 15°). The value obtained is the side roll rate due to one degree of rudder deflection, as shown in Figure 20.

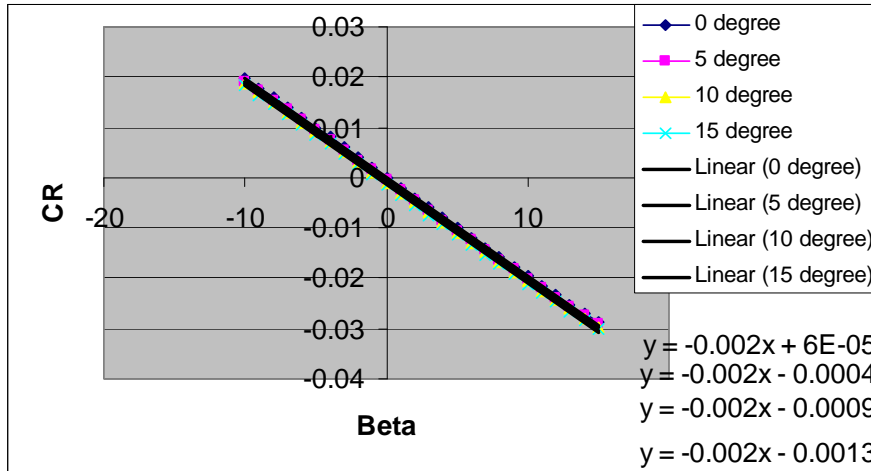

Figure 20. Curve for CIDr

17. CM_0 is the pitch moment at $AOA = 0$. CM_0 is the y-intercept for the curve between moment coefficient (CM) and AOA. It is obtained from the run where there is no control surfaces deflection, as shown in Figure 21.

18. CMA is the pitch moment due to angle of attack. It is the gradient of the curve between moment coefficient (CM) and AOA. Typically this is a negative gradient. It is obtained from the run where there is no control surfaces deflection, as shown in Figure 21.

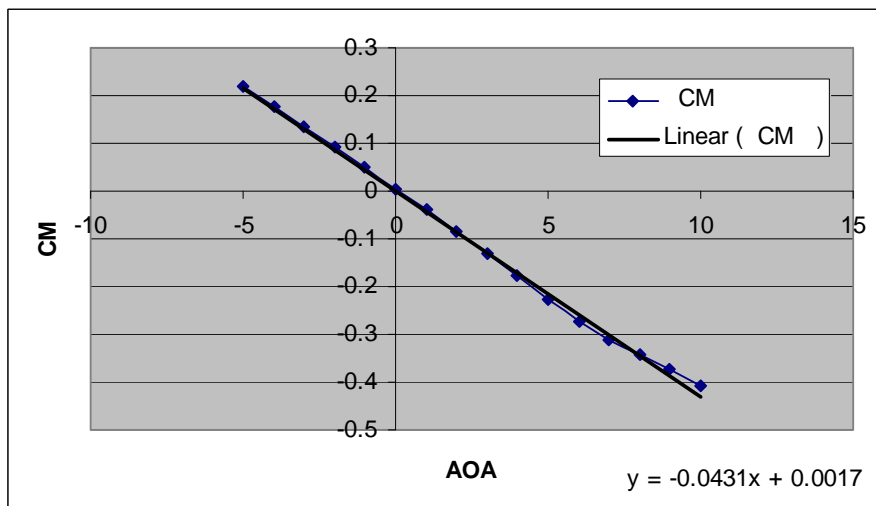

Figure 21. Curve for CM_0 and CMA

19. $CM_{\dot{\alpha}}$ is the pitch moment due to angle of attack rate. This value may be obtained by averaging the increase in pitching moment (CM) due to AOA from 0° to 15° .

20. CM_q is the pitch moment due to pitch rate. This is obtained by applying 1 rad/s pitch rate to the model without any control surfaces deflection. A curve of CM vs. AOA was plotted. The y-intercept is the pitch moment due to pitch rate of the UAV, as shown in Figure 22.

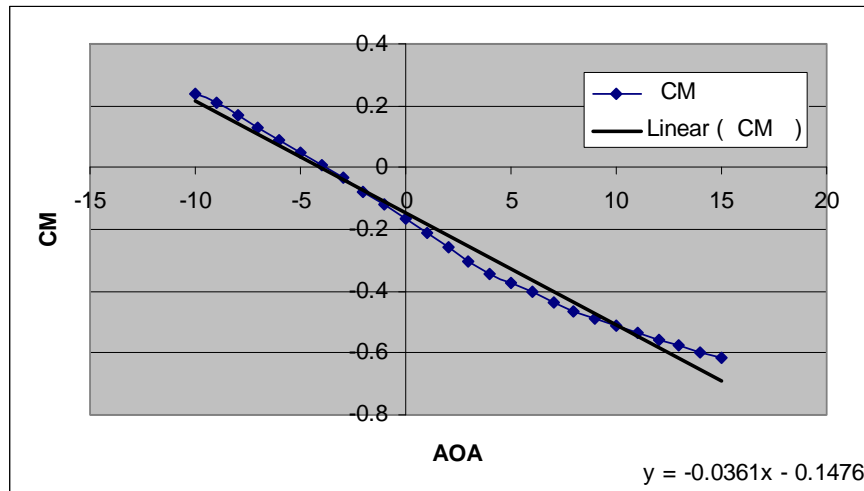

Figure 22. Curve for CM_q

21. CM_{δ_e} pitch control power is the moment due to elevator deflection. Various elevator deflection models were simulated, at 5° , 10° , and 15° . All three curves of CM vs. AOA were plotted in the same chart and follow almost the same gradient. Differences of the y-intercept between 0° and 15° curve were obtained and divided by 15 (since total deflection is 15°). This is the lift due to deflection of elevator per degree of deflection, as shown in Figure 23.

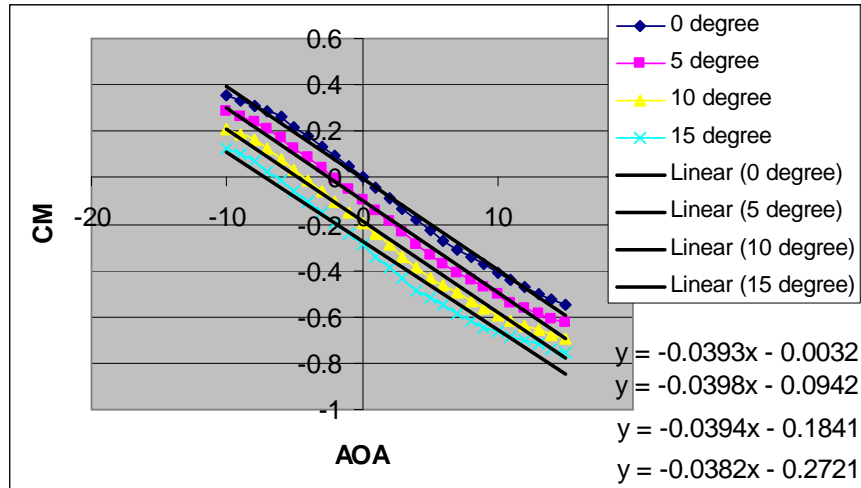

Figure 23. Curve for CMDe

22. CNb is the weathercock stability. It is the ability of an aircraft to return to its previous heading after being yawed as a result of wind effect [7]. This coefficient could be obtained from the gradient of the CN vs. Beta curve. This curve typically has a zero y-intercept, as shown in Figure 24.

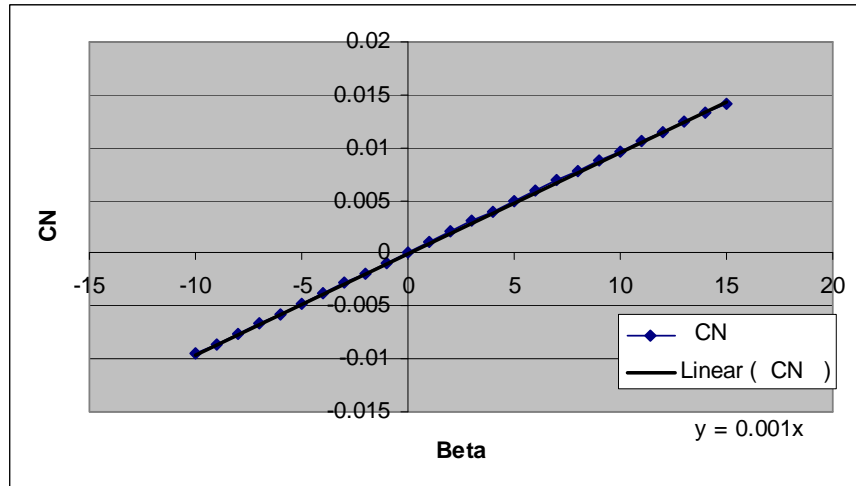

Figure 24. Curve for CNb

23. CNp is the adverse yaw of the UAV. This is obtained by applying 1 rad/s roll rate to the model without any control surfaces deflection. A curve of CN vs. Beta was plotted. The y-intercept is the adverse yaw effect of the UAV, as shown in Figure 25.

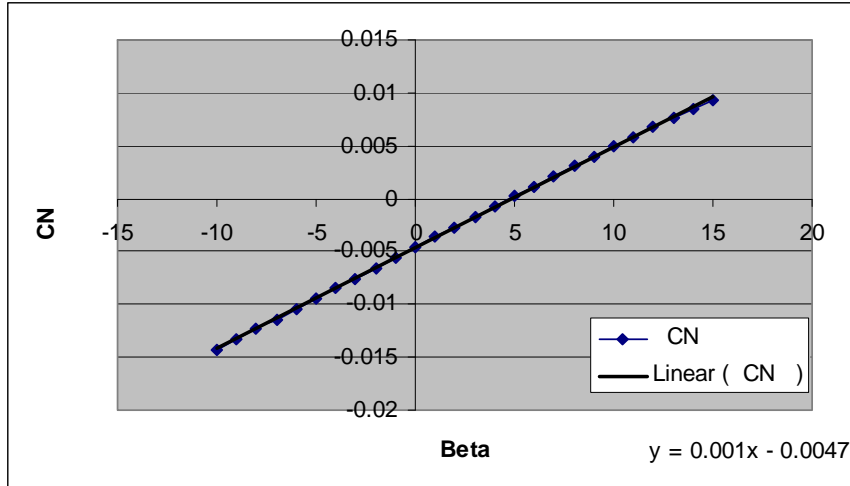

Figure 25. Curve for CNp

24. CNr is the yaw damping of the UAV. This is obtained by applying 1 rad/s yaw rate of the model without any control surfaces deflection. A curve of CN vs. Beta was plotted. The y-intercept is the yaw damping of the UAV, as shown in Figure 26.

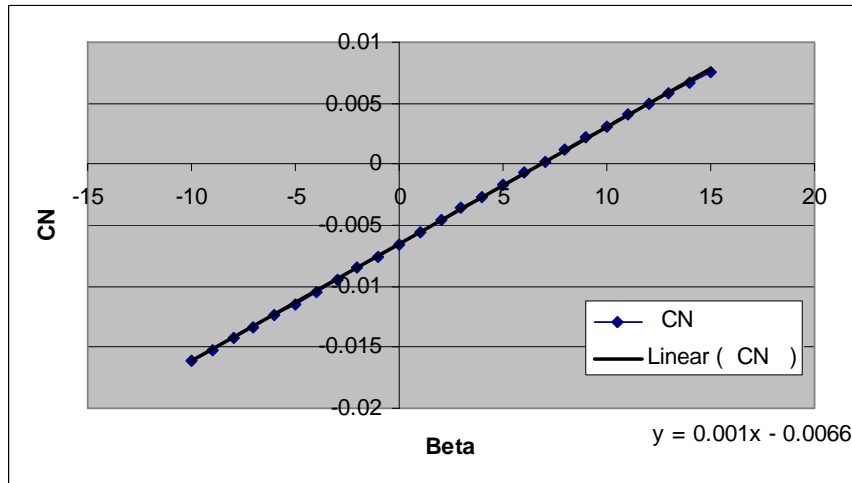

Figure 26. Curve for CNr

25. CNDa is the aileron adverse yaw of the UAV. It is the aileron control power due to aileron deflection. Various aileron deflection models were simulated, at 5°, 10°, and 15°. All three curves of CN vs. Beta were plotted in the same chart and follow almost the same gradient. Differences

of the y-intercept between 0° and 15° curves were obtained and divided by 15 (since total deflection is 15°). The value obtained is the yaw control power due to one degree of aileron deflection, as shown in Figure 27.

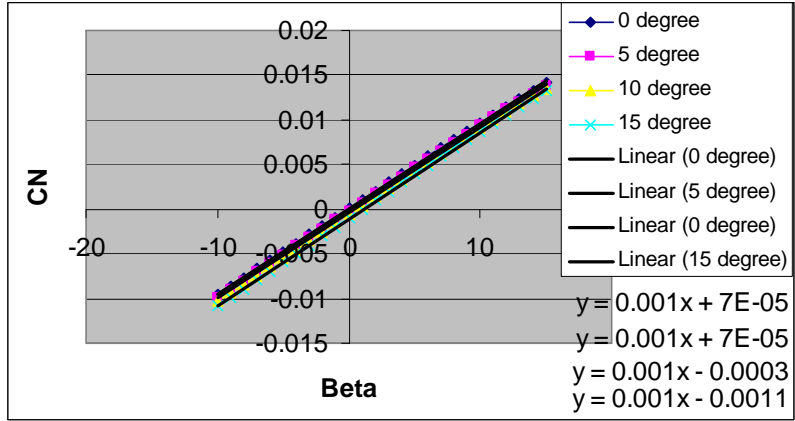

Figure 27. Curve for CN_{Da}

26. CN_{Dr} is the yaw control power of the UAV due to rudder deflection. Various rudder deflection models were simulated, at 5°, 10°, and 15°. All three curves of CN vs. Beta were plotted in the same chart and follow almost the same gradient. Differences of the y-intercept between 0° and 15° curves were obtained and divided by 15 (since total deflection is 15°). The value obtained is the yaw control power due to one degree of rudder deflection, as shown in Figure 28.

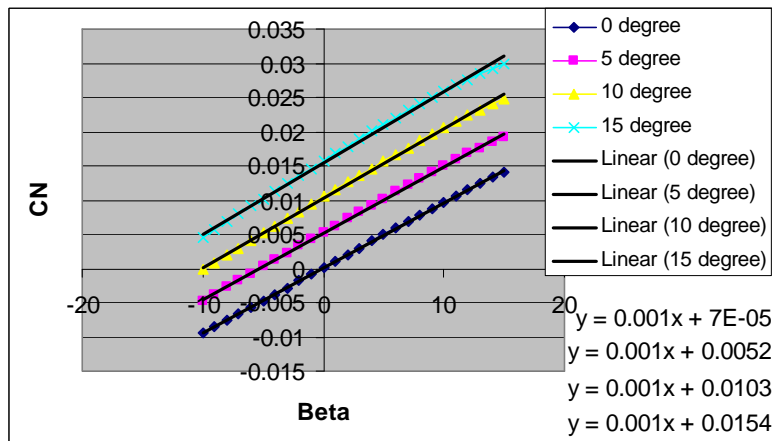

Figure 28. Curve for CN_{Dr}

Abbreviations	Nomenclatures	Pioneer ²⁶	Bluebird ³⁰	FROG ³¹	Old Silver Fox		New Silver Fox	P10B
		Analytical approach				Panel code		LinAir
CL0	<i>lift coefficient at $\alpha = 0$</i>	0.385	0.02345	0.4295	0.326	0.328	0.3243	0.2521
CLalpha	<i>lift curve slope</i>	4.78	4.1417	4.3034	4.68	5.097	6.0204	5.0420
CLa_dot	<i>lift due to angle of attack rate</i>	2.42	1.5787	1.3877	0.861	1.93	1.93	4.8890
CLq	<i>lift due to pitch rate</i>	8.05	3.9173	3.35	2.53	6.03	6.0713	5.6436
CLDe	<i>lift due to elevator</i>	0.401	0.413	0.3914	0.351	0.738	0.9128	0.3621
CD0	<i>drag coefficient at $C_L = 0$</i>	0.06	0.0311	0.0499	0.0187	0.0191	0.0251	0.0129
A1	<i>drag curve coefficient at C_L</i>	0.43	0.137	0.23	0	0	-0.0241	0.0004
A2	<i>drag curve coefficient at C_L^2</i>				0.0413	0.0377	0.0692	0.0774
CDDe	<i>drag due to elevator</i>	0.018	0.065	0.00676	0.0486	0.104	0.1	0.0431
CYb	<i>side force due to sideslip</i>	-0.819	-0.31	-0.31	-0.31	-0.204	-0.3928	-0.2922
CYDr	<i>side force due to rudder</i>	0.191	0.0697	0.0926	0.0613	0.112	0.1982	0.1587
Clb	<i>dihedral effect</i>	-0.023	-0.033	-0.0509	-0.0173	-0.0598	-0.0113	-0.1146
Clp	<i>roll damping</i>	-0.45	-0.3579	-0.3702	-0.363	-0.363	-1.2217	-4.0508
Clr	<i>roll due to yaw rate</i>	0.265	0.0755	0.1119	0.0839	0.0886	0.015	0.3495
CIDa	<i>roll control power</i>	0.161	0.2652	0.181	0.265	0.265	0.3436	0.4509
CIDr	<i>roll due to rudder</i>	-0.00229	0.0028	0.0036	0.0027	0.0064	0.0076	0.0052
Cm0	<i>pitch moment at $\alpha = 0$</i>	0.194	0.0364	0.051	0.0438	0.008	0.0272	0.0974
Cma	<i>pitch moment due to angle of attack</i>	-2.12	-1.0636	-0.5565	-0.836	-2.051	-1.9554	-2.4694
Cma_dot	<i>pitch moment due to angle of attack rate</i>	-11	-4.679	-3.7115	-2.09	-5.286	-5.286	-2.0695
Cmq	<i>pitch moment due to pitch rate</i>	-36.6	-11.6918	-8.8818	-6.13	-16.52	-9.5805	-8.4569
CmDe	<i>pitch control power</i>	-1.76	-1.2242	-1.0469	-0.849	-2.021	-2.4808	-1.0273
Cnb	<i>weathercock stability</i>	0.109	0.0484	0.0575	0.0278	0.0562	0.0804	0.0573
Cnp	<i>adverse yaw</i>	-0.11	-0.0358	-0.0537	-0.0407	-0.0407	-0.0557	-0.2693
Cnr	<i>yaw damping</i>	-0.2	-0.0526	-0.0669	-0.0232	-0.0439	-0.1422	-0.3782
CnDa	<i>aileron adverse yaw</i>	-0.02	-0.0258	-0.0272	-0.0294	-0.0296	-0.0165	-0.0045
CnDr	<i>yaw control power</i>	-0.0917	-0.0326	-0.0388	-0.0186	-0.0377	-0.0598	-0.0586

Table 2. Consolidation of P-10B coefficient Using LinAir (After [1])

E. AVL MODEL

The first step in AVL modeling is to define the fuselage of the UAV. As AVL is only able to model circular fuselages, equivalent areas were used. In addition, the dimensions for the P-10B were scaled down by 50% since an AVL fuselage is limited to 100 units or less. The following parameters were used to create the fuselage, as shown in Figure 29.

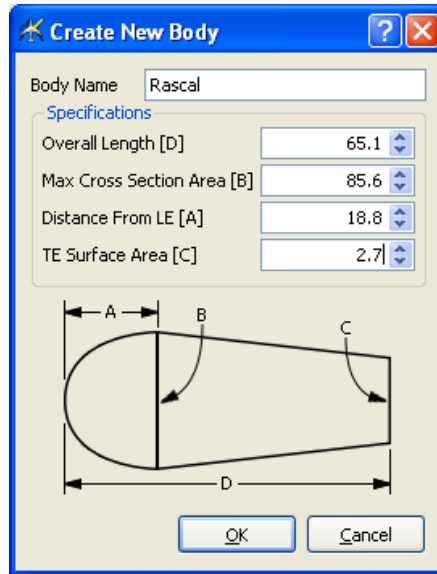

Figure 29. AVL GUI to create fuselage

The next step was to define the airfoil required for the model. The airfoil editor was activated, as shown in Figure 30. Defining of NACA airfoil is done by simply entering the airfoil number. NACA 0008 is defined for vertical and horizontal stabilizers. The wing uses a Clark Y airfoil. Non-NACA airfoils can be defined by loading the airfoil profile that comes in the form of a text file. It is important to note that the airfoil profile should start from $x = 1.00000$ (trailing edge) and proceed towards zero value going around the leading edge and back to the trailing edge. The connecting point should be at the trailing edge, shown as a small circle in Figure 31.

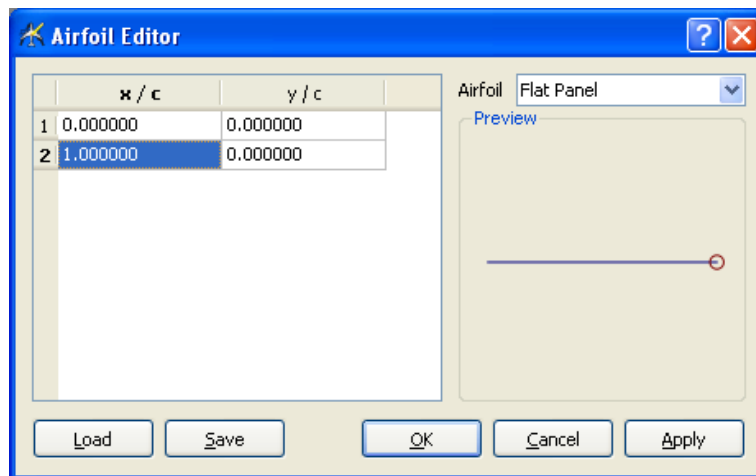

Figure 30. AVL Airfoil Editor

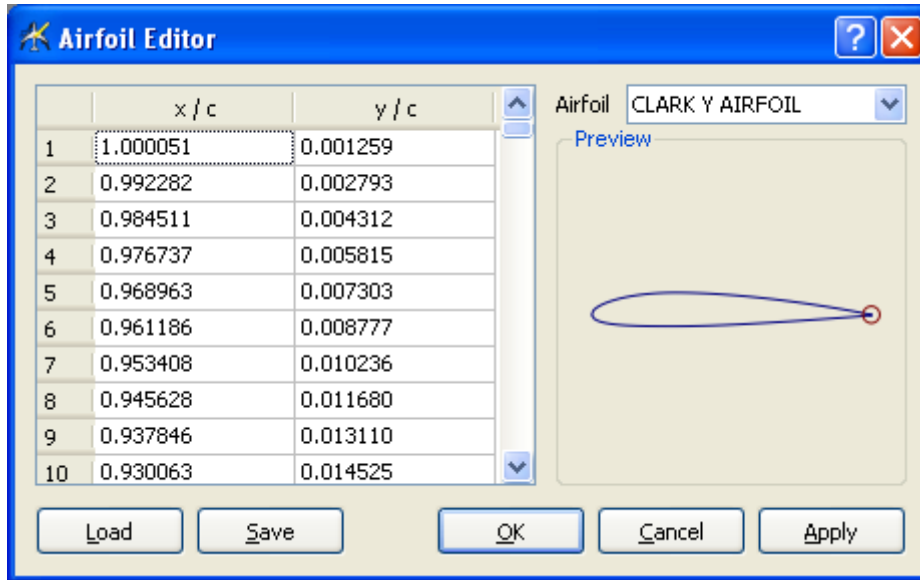

Figure 31. AVL NACA Clark Y Airfoil Profile Input

Once the airfoils are defined, the next step is to define the surfaces. This includes all surfaces, excluding the fuselage that was defined previously. The surfaces were defined using a surface editor, as shown in Figure 32. The coordinates from the MS Excel model were used as an input to the surface editor.

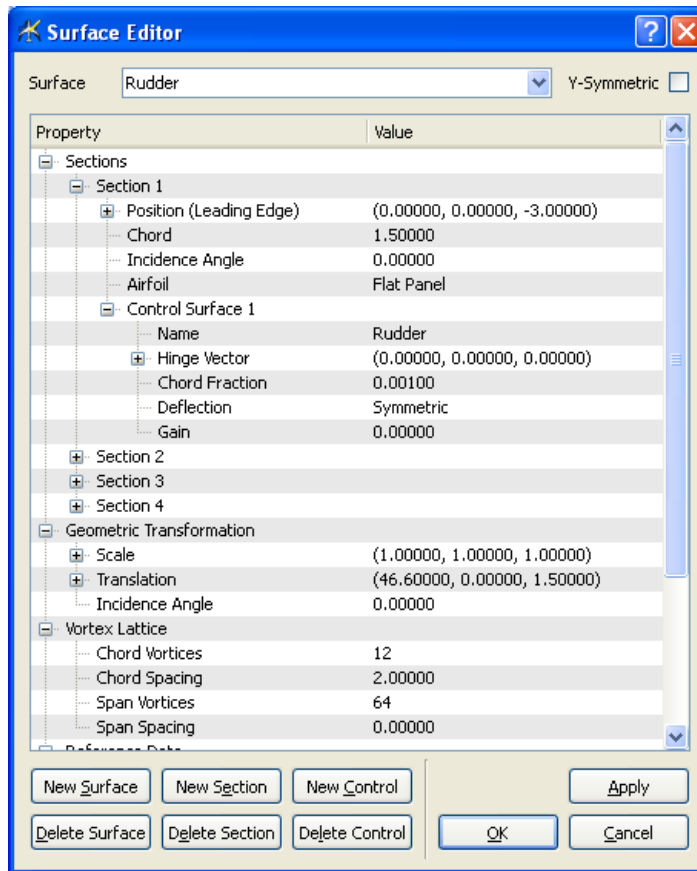

Figure 32. AVL GUI for surface editor

The complete P-10B model in AVL is shown in Figure 33.

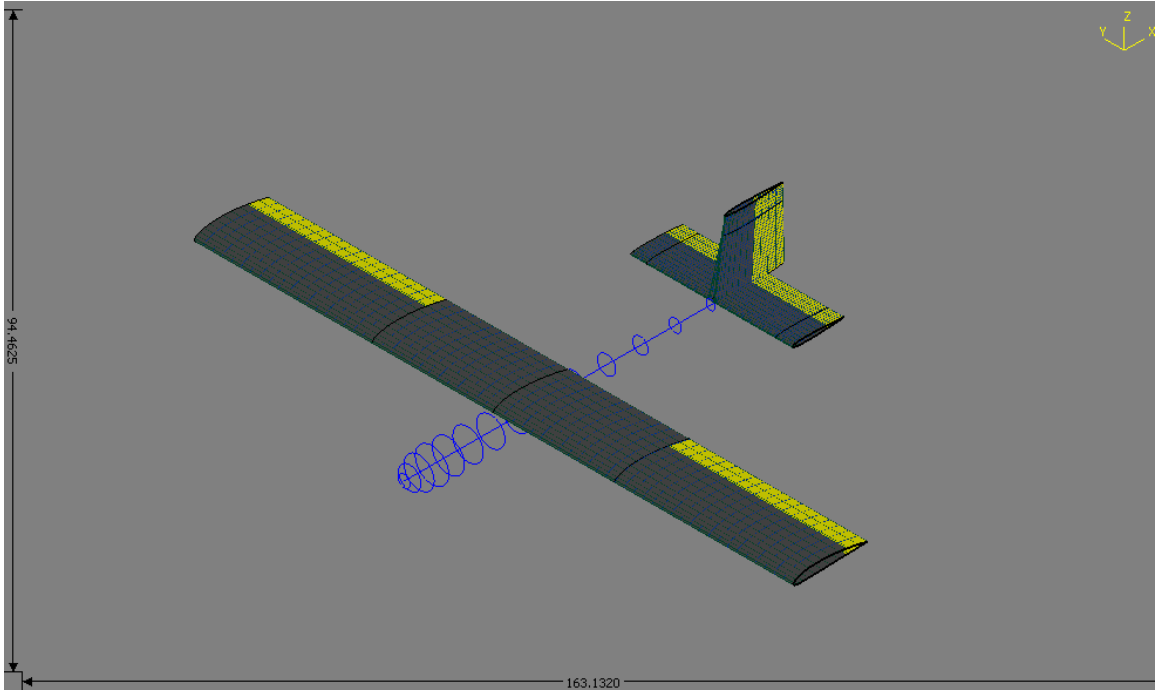

Figure 33. P-10B Model in AVL

Unfortunately, AVL is unable to generate positive results for the P-10B model.

III. MODELING OF RASCAL UAV

A. BACKGROUND

Rascal UAV is an in-house integrated UAV that is often used as a test bed for various UAV operation concepts and scenarios. The Rascal UAV uses a remote controlled aircraft (Sig Rascal) as the airframe platform, and integrates the following components:

- Cloud Cap Technology Piccolo II Autopilot Avionics
- GPS
- pitot-static probe
- magnetometer
- 900 MHz radio modems for GCS link
- PC/104 onboard computers (2)
- 2.4 GHz “Mesh” wireless networking card
- Video camera with custom 2-axis gimbals
- Pelco network digital video server

The integrated Rascal UAV weighs 13 pounds, measures 6 feet long, has a 9 foot wingspan, and has an endurance of 2 hours. The Rascal UAV has been a test bed for various UAV capabilities research and testing. [8]

B. GEOMETRY

Since the Rascal UAV is a hobby remote controlled aircraft, and no engineering drawing can be found, physical measurement of the airframe is performed. The UAV is divided into fuselage, wings, horizontal stabilizer, and vertical stabilizer. The measurements are converted into the graphical model shown in Appendix B, using MS Visio.

It was also found that the center of gravity of the airframe is 2.5 inches from the leading edge of the wing, along the X axis and center of the airframe height.

The wing uses NACA 2312 airfoil with a 2% camber at a distance of 0.3% of the total cord length from the leading edge, with a 12% thickness. The cross sectional view of the airfoil is as shown in Figure 34.

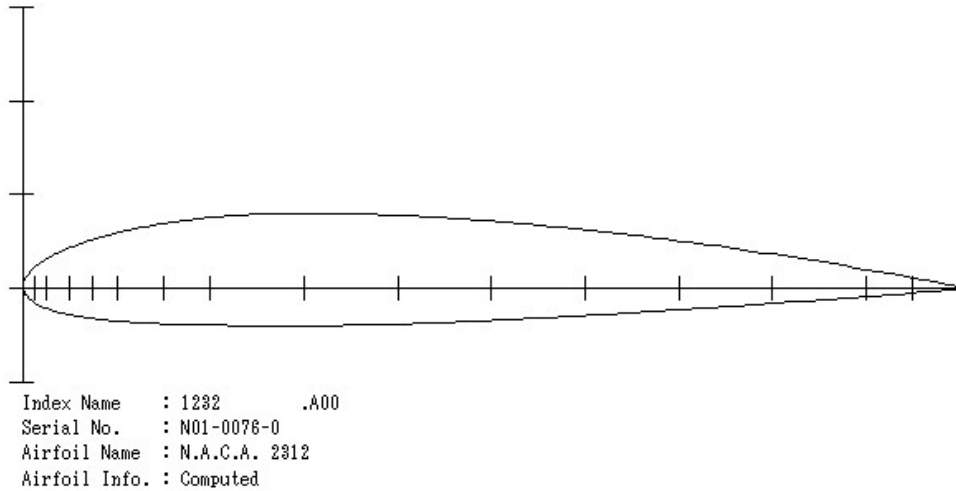

Figure 34. Cross sectional view of NACA 2312 airfoil[9]

Similarly to the P-10B model, the next step is to determine the drag coefficient after identifying the airfoil number (reference Figure 35. $CD_0 = 0.017$ for 1° AOA since the wingspan is mounted at 1 degree angle.

$$A_2 = \frac{1}{\pi \times AR \times \epsilon}$$

$$AR = \frac{110.4^2}{712.27} = 17.11171$$

Assuming $\epsilon=0.9$

$$A_2 = \frac{1}{\pi \times 17.11171 \times 0.9} = 0.020668746$$

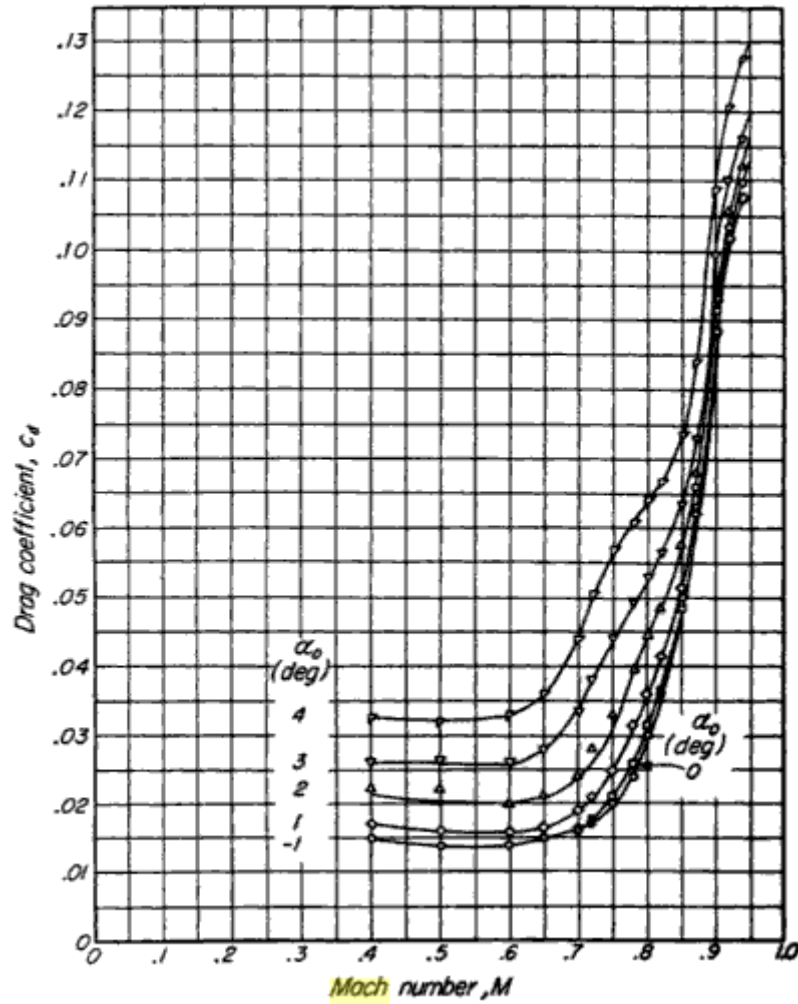

Figure 35. NACA 2312 Drag Coefficient vs. Mach [10]

Alternatively the CD parameters could be computed using the AVL program. A portion of the NACA airfoil was created in AVL program as shown in Figure 36. The CD vs. CL curve obtained from the results is shown in Figure 37. From the curve, the CD coefficients are as follows,

- $CD_0 = 0.000033$
- $CD_1 = -0.0043$
- $CD_2 = 0.0002$

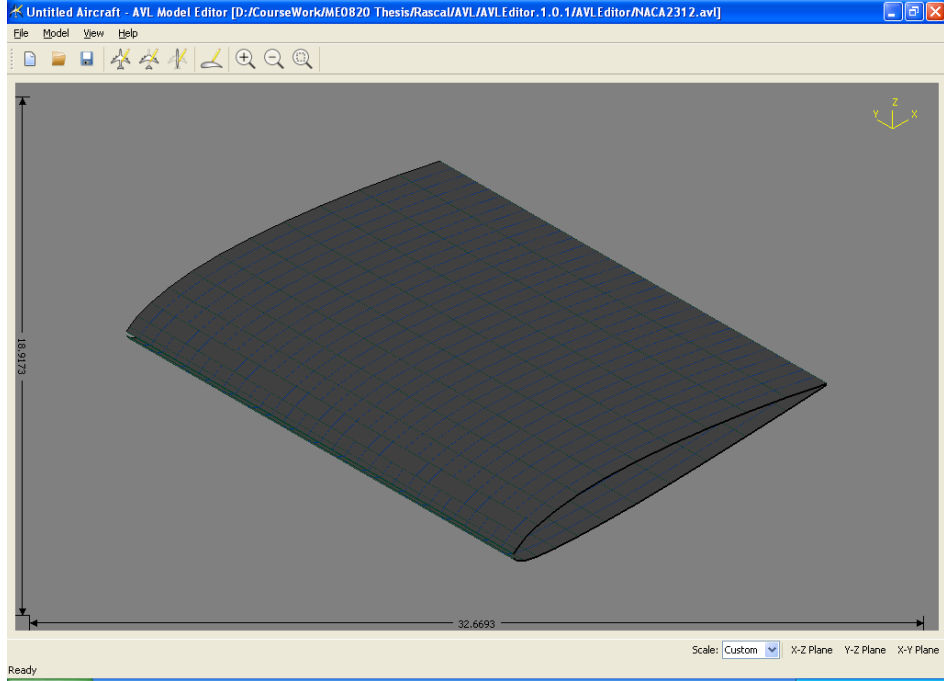

Figure 36. NACA 2312 airfoil in AVL

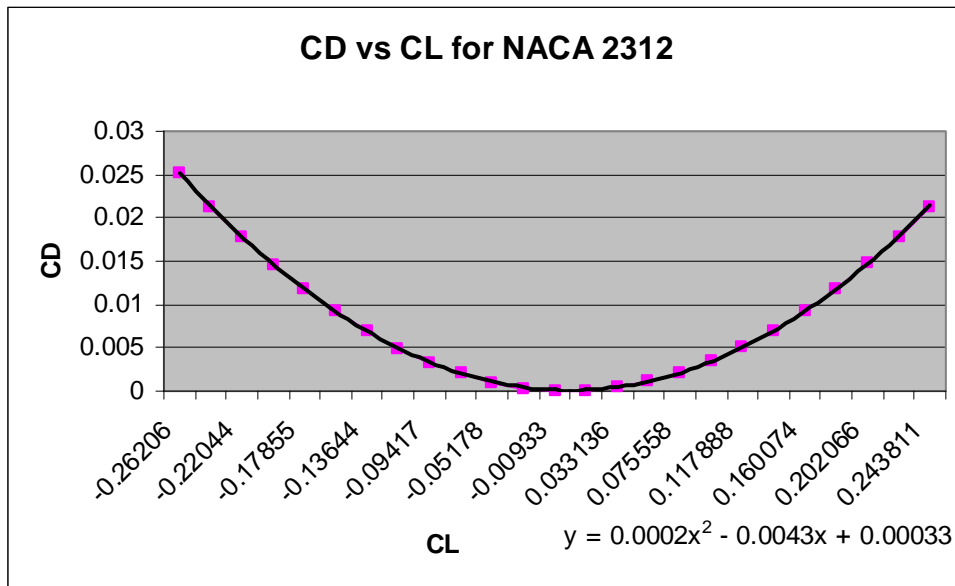

Figure 37. CD vs. CL for NACA 2312 using AVL

C. MS EXCEL MODEL

Once again, English units were adopted. The MS Excel model created has 28 elements that consist of the following:

- 5 elements for vertical fuselage
- 4 elements for horizontal fuselage
- 3 elements for left wing
- 3 elements for right wing
- 1 element for left aileron
- 1 element for right aileron
- 3 elements for horizontal stabilizer
- 2 elements for left elevator
- 2 elements for right elevator
- 2 elements for vertical stabilizer
- 2 elements for rudder

The Sref (wings area) is computed to be 712.27 square inches. From the geometry model, the Bref (wing span) is determined to be 110.4 inches. Once the base model is completed, it is modified to adjust the coordination of the control surfaces (aileron, elevator, and rudder) with the input of angle of deflection.

D. LINAIR MODEL

Figure 38. shows the LinAir model for the Rascal UAV, with the input file attached in Appendix C. The following three charts were generated to verify that the model is correct.

- Contribution of force component in the Y axis for the entire model; refer to Figure 39.
- Alpha vs. lift coefficient (CL); refer to Figure 40.
- Drag coefficient (CD) vs. lift coefficient (CL); refer to Figure 41.

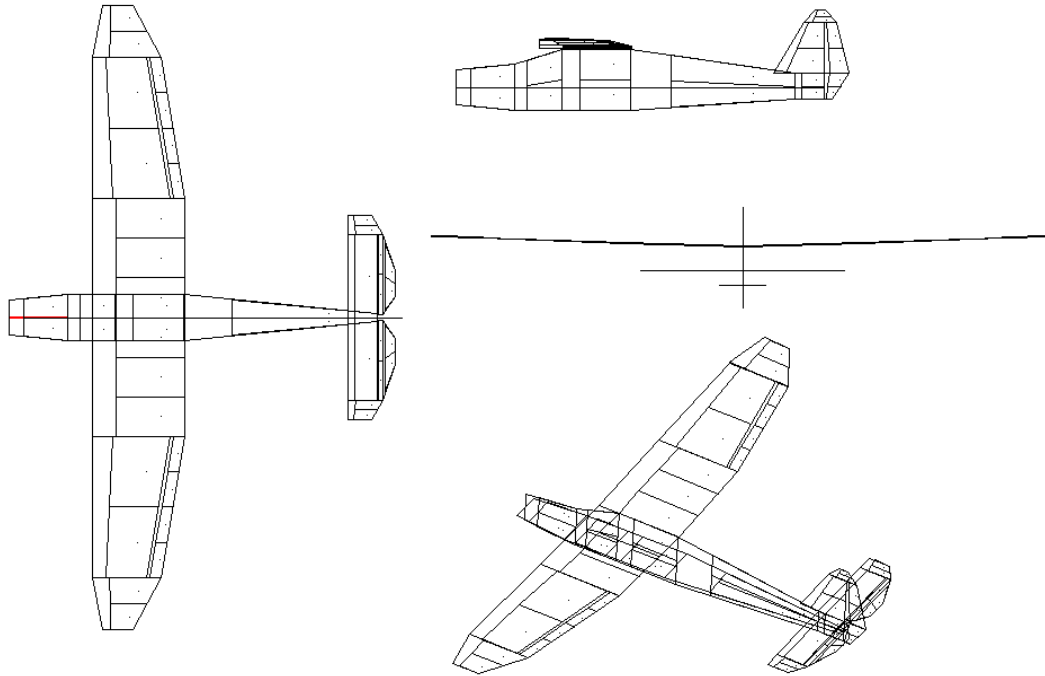

Figure 38. Rascal LinAir model

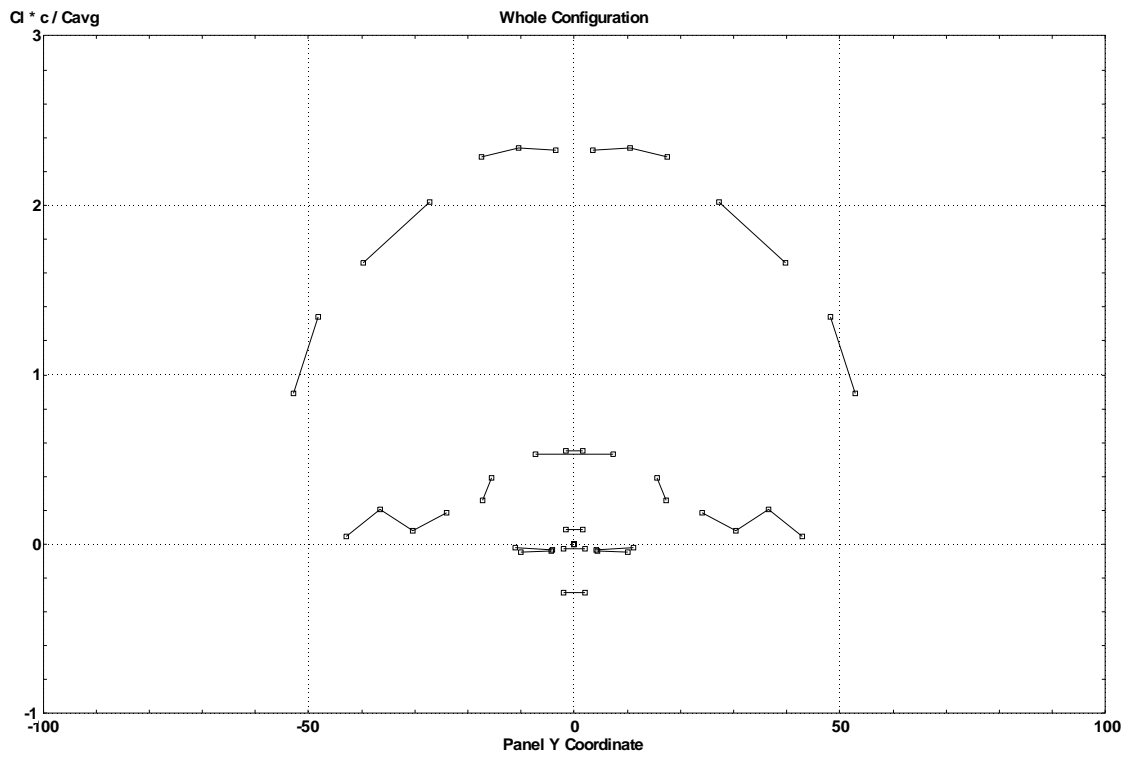

Figure 39. Force contribution along Y axis for Rascal LinAir Model

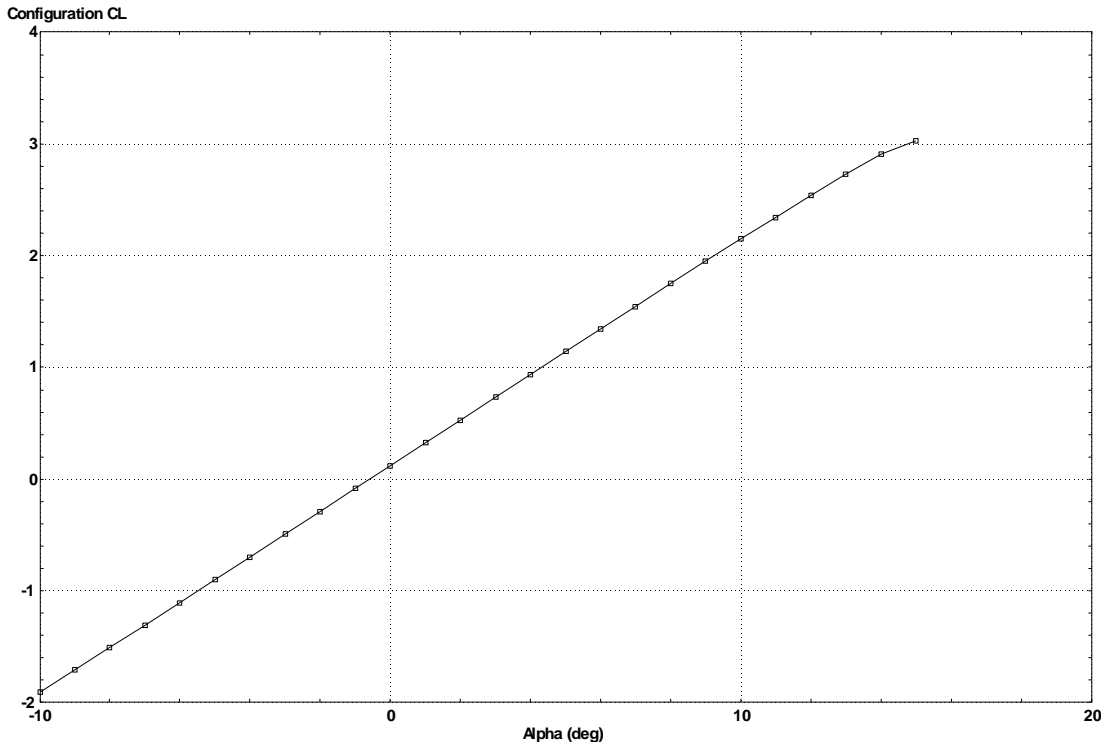

Figure 40. Lift coefficient vs. AOA for Rascal LinAir model

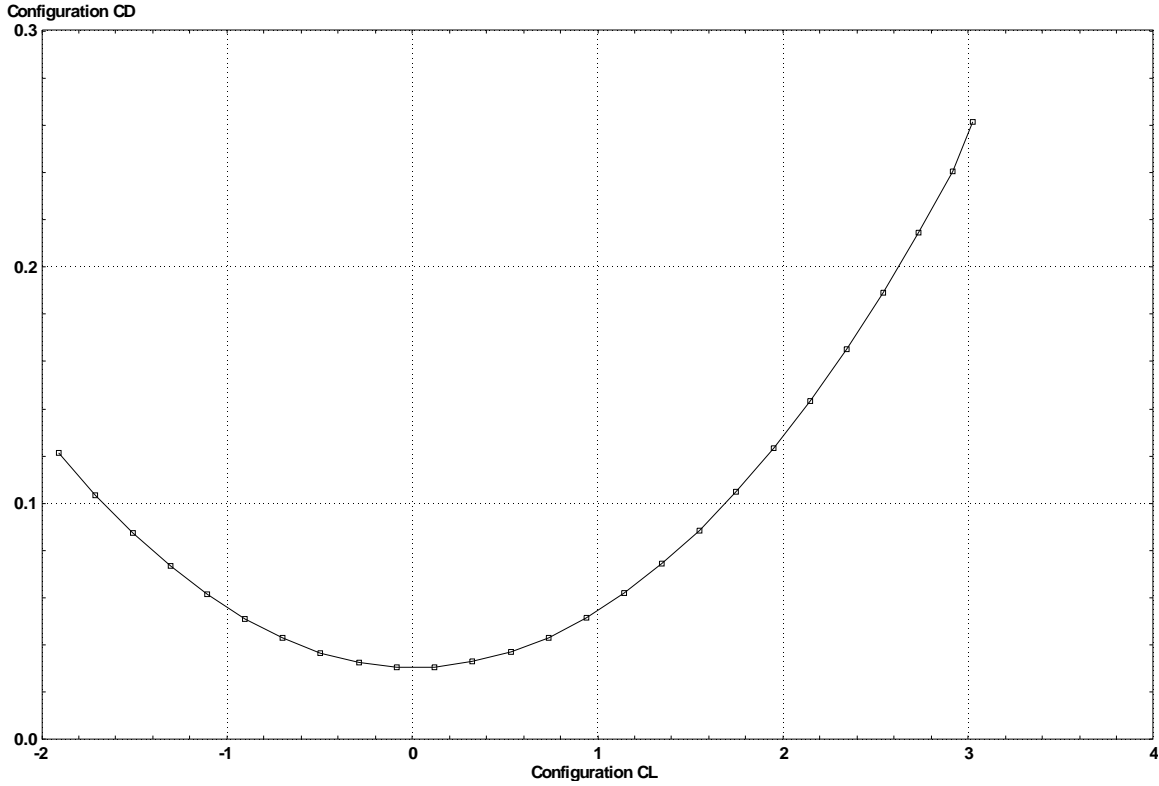

Figure 41. Drag coefficient vs. lift coefficient for Rascal LinAir model

Following the same procedure as P-10B model in Section II, the following coefficients for Rascal were determined:

Abbreviations	Nomenclatures	Pioneer ²⁶	Bluebird ³⁰	FROG ³¹	Old Silver Fox	New Silver Fox	Rascal	
		Analytical approach				Panel code		LinAir
CL0	<i>lift coefficient at $\alpha = 0$</i>	0.385	0.02345	0.4295	0.326	0.328	0.3243	6.6291
CLalpha	<i>lift curve slope</i>	4.78	4.1417	4.3034	4.68	5.097	6.0204	11.5508
CLa_dot	<i>lift due to angle of attack rate</i>	2.42	1.5787	1.3877	0.861	1.93	1.93	11.3033
CLq	<i>lift due to pitch rate</i>	8.05	3.9173	3.35	2.53	6.03	6.0713	13.2525
CLDe	<i>lift due to elevator</i>	0.401	0.413	0.3914	0.351	0.738	0.9128	0.7659
CD0	<i>drag coefficient at $C_L = 0$</i>	0.06	0.0311	0.0499	0.0187	0.0191	0.0251	0.0250
A1	<i>drag curve coefficient at C_L</i>	0.43	0.137	0.23	0	0	-0.0241	-0.0006
A2	<i>drag curve coefficient at C_L^2</i>				0.0413	0.0377	0.0692	0.0301
CDDe	<i>drag due to elevator</i>	0.018	0.065	0.0.0676	0.0486	0.104	0.1	0.0592
CYb	<i>side force due to sideslip</i>	-0.819	-0.31	-0.31	-0.31	-0.204	-0.3928	-1.8678
CYDr	<i>side force due to rudder</i>	0.191	0.0697	0.0926	0.0613	0.112	0.1982	0.2067
Clb	<i>dihedral effect</i>	-0.023	-0.033	-0.0509	-0.0173	-0.0598	-0.0113	-0.1490

Abbreviations	Nomenclatures	Pioneer ²⁶	Bluebird ³⁰	FROG ³¹	Old Silver Fox	New Silver Fox	Rascal	
		Analytical approach				Panel code		LinAir
Clp	<i>roll damping</i>	-0.45	-0.3579	-0.3702	-0.363	-0.363	-1.2217	-3.2258
Clr	<i>roll due to yaw rate</i>	0.265	0.0755	0.1119	0.0839	0.0886	0.015	0.4011
CIDa	<i>roll control power</i>	0.161	0.2652	0.181	0.265	0.265	0.3436	0.4771
CIDr	<i>roll due to rudder</i>	-0.00229	0.0028	0.0036	0.0027	0.0064	0.0076	0.0057
Cm0	<i>pitch moment at $\alpha = 0$</i>	0.194	0.0364	0.051	0.0438	0.008	0.0272	3.6154
Cma	<i>pitch moment due to angle of attack</i>	-2.12	-1.0636	-0.5565	-0.836	-2.051	-1.9554	-4.9561
Cma_dot	<i>pitch moment due to angle of attack rate</i>	-11	-4.679	-3.7115	-2.09	-5.286	-5.286	-5.0277
Cmq	<i>pitch moment due to pitch rate</i>	-36.6	-11.6918	-8.8818	-6.13	-16.52	-9.5805	-24.2991
CmDe	<i>pitch control power</i>	-1.76	-1.2242	-1.0469	-0.849	-2.021	-2.4808	-4.8457
Cnb	<i>weathercock stability</i>	0.109	0.0484	0.0575	0.0278	0.0562	0.0804	0.5500
Cnp	<i>adverse yaw</i>	-0.11	-0.0358	-0.0537	-0.0407	-0.0407	-0.0557	-0.0630
Cnr	<i>yaw damping</i>	-0.2	-0.0526	-0.0669	-0.0232	-0.0439	-0.1422	-0.7735
CnDa	<i>aileron adverse yaw</i>	-0.02	-0.0258	-0.0272	-0.0294	-0.0296	-0.0165	-0.0020
CnDr	<i>yaw control power</i>	-0.0917	-0.0326	-0.0388	-0.0186	-0.0377	-0.0598	-0.0863

Table 3. Consolidation of Rascal coefficients using LinAir (After [1])

E. AVL MODEL

The same procedures were performed as in the case of P-10B model for AVL. The fuselage was defined in full scale, since the entire UAV is less than 100 inches in length. NACA 2312 was defined while a flat plate was used for vertical and horizontal stabilizers. The complete Rascal model is shown in Figure 42.

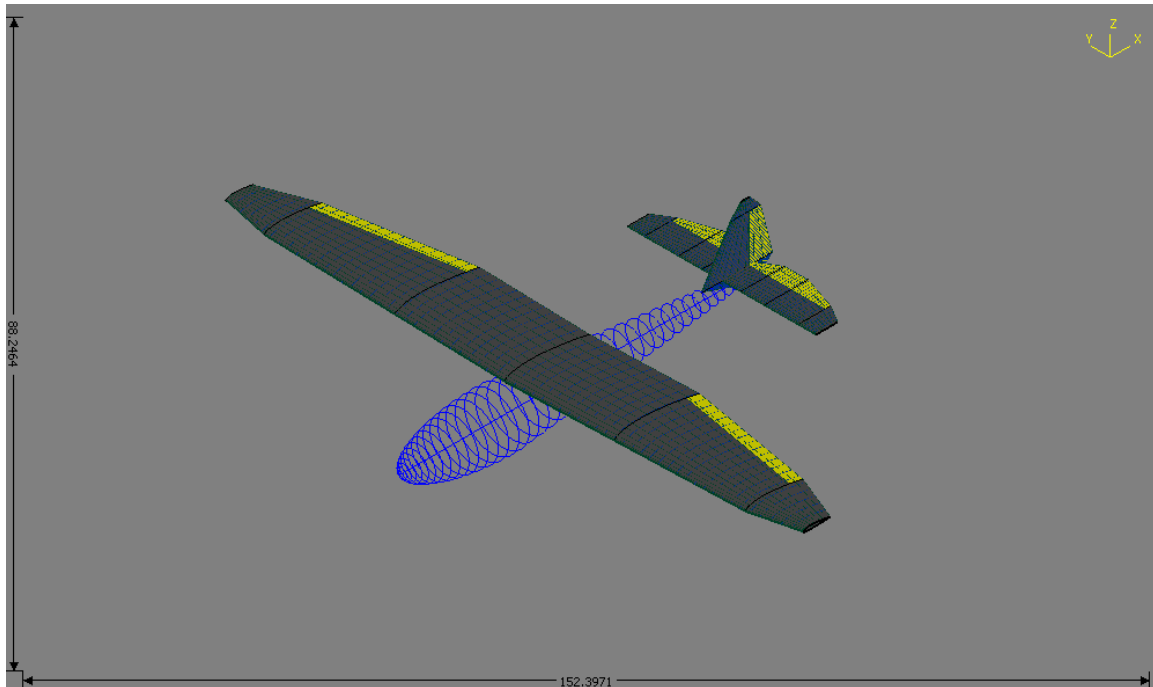

Figure 42. Rascal Model in AVL

Using the same procedure as set out in P-10B, the following coefficients for Rascal were determined:

Abbreviations	Nomenclatures	Pioneer ²⁶	Bluebird ³⁰	FROG ³¹	Old Silver Fox	New Silver Fox	Rascal	
		Analytical approach				Panel code		AVL
CL0	<i>lift coefficient at $\alpha = 0$</i>	0.385	0.02345	0.4295	0.326	0.328	0.3243	
CLalpha	<i>lift curve slope</i>	4.78	4.1417	4.3034	4.68	5.097	6.0204	
CLa_dot	<i>lift due to angle of attack rate</i>	2.42	1.5787	1.3877	0.861	1.93	1.93	
CLq	<i>lift due to pitch rate</i>	8.05	3.9173	3.35	2.53	6.03	6.0713	
CLDe	<i>lift due to elevator</i>	0.401	0.413	0.3914	0.351	0.738	0.9128	
CD0	<i>drag coefficient at $C_L = 0$</i>	0.06	0.0311	0.0499	0.0187	0.0191	0.0251	
A1	<i>drag curve coefficient at C_L</i>	0.43	0.137	0.23	0	0	-0.0241	
A2	<i>drag curve coefficient at C_L^2</i>				0.0413	0.0377	0.0692	
CDDe	<i>drag due to elevator</i>	0.018	0.065	0.00676	0.0486	0.104	0.1	
CYb	<i>side force due to sideslip</i>	-0.819	-0.31	-0.31	-0.31	-0.204	-0.3928	
CYDr	<i>side force due to rudder</i>	0.191	0.0697	0.0926	0.0613	0.112	0.1982	
Clb	<i>dihedral effect</i>	-0.023	-0.033	-0.0509	-0.0173	-0.0598	-0.0113	
Clp	<i>roll damping</i>	-0.45	-0.3579	-0.3702	-0.363	-0.363	-1.2217	

Abbreviations	Nomenclatures	Pioneer ²⁶	Bluebird ³⁰	FROG ³¹	Old Silver Fox	New Silver Fox	Rascal
		Analytical approach				Panel code	AVL
Clr	<i>roll due to yaw rate</i>	0.265	0.0755	0.1119	0.0839	0.0886	0.015
CIDa	<i>roll control power</i>	0.161	0.2652	0.181	0.265	0.265	0.3436
CIDr	<i>roll due to rudder</i>	-0.00229	0.0028	0.0036	0.0027	0.0064	0.0076
Cm0	<i>pitch moment at $a = 0$</i>	0.194	0.0364	0.051	0.0438	0.008	0.0272
Cma	<i>pitch moment due to angle of attack</i>	-2.12	-1.0636	-0.5565	-0.836	-2.051	-1.9554
Cma_dot	<i>pitch moment due to angle of attack rate</i>	-11	-4.679	-3.7115	-2.09	-5.286	-5.286
Cmq	<i>pitch moment due to pitch rate</i>	-36.6	-11.6918	-8.8818	-6.13	-16.52	-9.5805
CmDe	<i>pitch control power</i>	-1.76	-1.2242	-1.0469	-0.849	-2.021	-2.4808
Cnb	<i>weathercock stability</i>	0.109	0.0484	0.0575	0.0278	0.0562	0.0804
Cnp	<i>adverse yaw</i>	-0.11	-0.0358	-0.0537	-0.0407	-0.0407	-0.0557
Cnr	<i>yaw damping</i>	-0.2	-0.0526	-0.0669	-0.0232	-0.0439	-0.1422
CnDa	<i>aileron adverse yaw</i>	-0.02	-0.0258	-0.0272	-0.0294	-0.0296	-0.0165
CnDr	<i>yaw control power</i>	-0.0917	-0.0326	-0.0388	-0.0186	-0.0377	-0.0598

Table 4. Consolidation of Rascal coefficients using AVL (After [1])

THIS PAGE INTENTIONALLY LEFT BLANK

IV. SIMULINK MODEL

A. MOMENT OF INERTIA

With the above coefficient computed from the LinAir model or AVL model. The next parameter required by the simulink 6DOF model is the three moment of inertia for the x axis, y axis, and z axis. As the information of the moment of inertia for both P10B and rascal are not available, an estimation of the moment of inertia were done using the following formulas,

$$I_{XX} = I_{XX,ref} \frac{mass}{mass_{ref}} \frac{span^2}{span_{ref}^2}$$

$$I_{YY} = I_{YY,ref} \frac{mass}{mass_{ref}} \frac{lenght^2}{lenght_{ref}^2}$$

$$I_{ZZ} = I_{ZZ,ref} \frac{mass}{mass_{ref}} \frac{span^2}{span_{ref}^2}$$

		Bluebird ³⁰	FROG ³¹	Old Silver Fox	New Silver Fox	P10B	Rascal
S	<i>reference area of wing, m²</i>	2.0790	1.6260	0.6360		4.9161	0.4595
b	<i>wingspan, m</i>	3.7856	3.2250	2.4100		6.4516	2.8042
c	<i>mean aerodynamic chord, m</i>	0.549	0.500	0.264		0.762	0.164
m	<i>gross weight, kg</i>	26.2	30.7	10.0		63.0	5.9
F	<i>fuselage length, m</i>	2.9	1.9	1.47		3.2258	1.6535
V	<i>cruise velocity, m/s</i>	27.0	27.0	26.00		31.29	30.00
Ixx	<i>roll inertia, kgm²</i>	17.1	17.0	1.00		45.00	0.80
Iyy	<i>pitch inertia, kgm²</i>	17.9	11.4	0.87		26.00	0.70
Izz	<i>yaw inertia, kgm²</i>	27.1	25.2	1.40		61.00	1.20

Table 5. Moment of inertia for P10B(After [1])

Using the code as shown in Appendix G, the trim condition for each UAV are determined as shown in Table 6.

	P10B	Rascal	Rascal
	LinAir		AVL
<i>Velocity (m/s)</i>	30	27	27
<i>AOA Trim (degree)</i>	-0.7083	4.0527	3.7730
<i>Elevation trim, detrim (degree)</i>	7.1349	-2.8911	-34.8740
<i>Thrust Trim (N)</i>	45.4511	4.7809	56.1161

Table 6. Aerodynamic model parameter at trim condition

The trim parameter for the Rascal UAV coefficient generated by AVL, is logical. The elevator has to deflect by -34 degree, but the model has limited the maximum deflection to ± 15 degree. In addition, the thrust required is an order of magnitude larger than the LinAir's result.

B. P10B SIMULATION RESULTS

With the aerodynamic coefficient, moment of inertia, and trim condition parameter, simulation were performed to verify that the aerodynamic coefficient determined are good enough to be used for simulation.

1. Trim condition

The first simulation was to determine whether the UAV is stable at trim condition. Figure 43. shows that the longitudinal channel of the UAV. It demonstrated an initial short period of disturbance that dies of in about 1 second. Following on is a long period of small oscillation. The magnitude of this oscillation is small, less than 10 meter for altitude. Figure 44. shows that the at trim condition, the horizontal channel of the UAV is constant at zero.

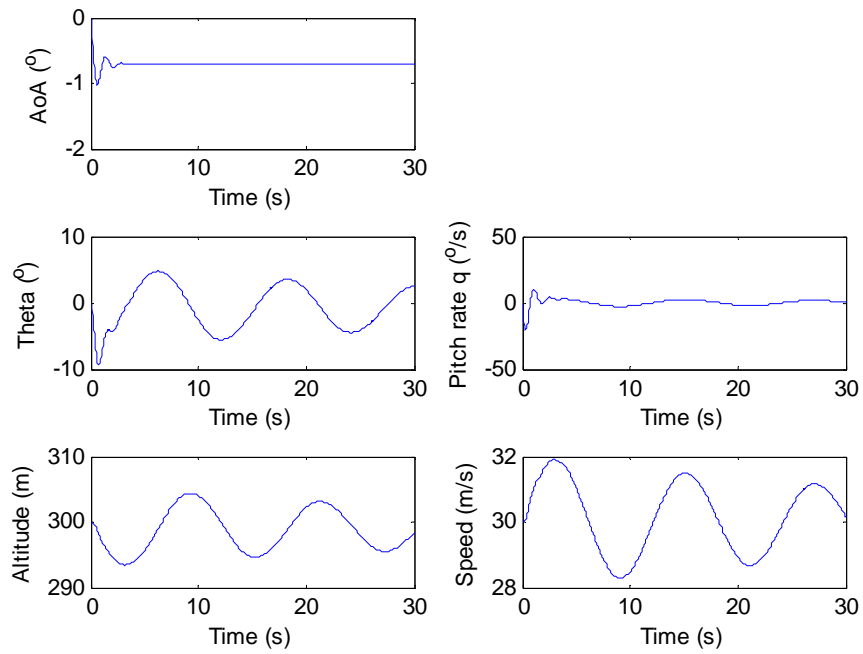

Figure 43. P10B longitudinal channel at trim condition

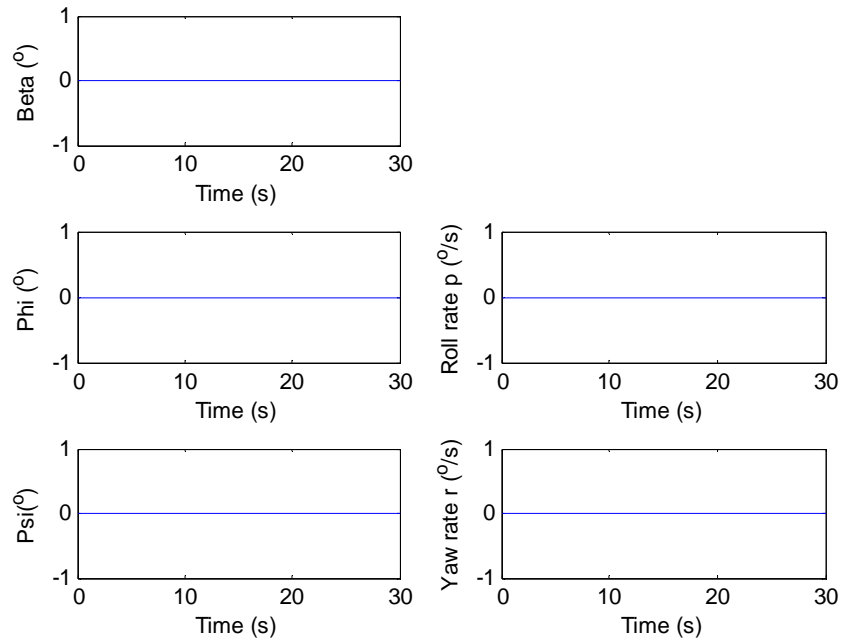

Figure 44. P10B lateral channel at trim condition

2. Change in Thrust Parameter

Once the trim condition of the UAV was verified, the thrust of the model is varied to verify the behavior of the model. Figure 45. shows that with a 10N increase in thrust, the UAV start to climb in altitude. This is due to more lift generated with additional speed generated from the additional thrust. The rest of the vertical channel does not change much.

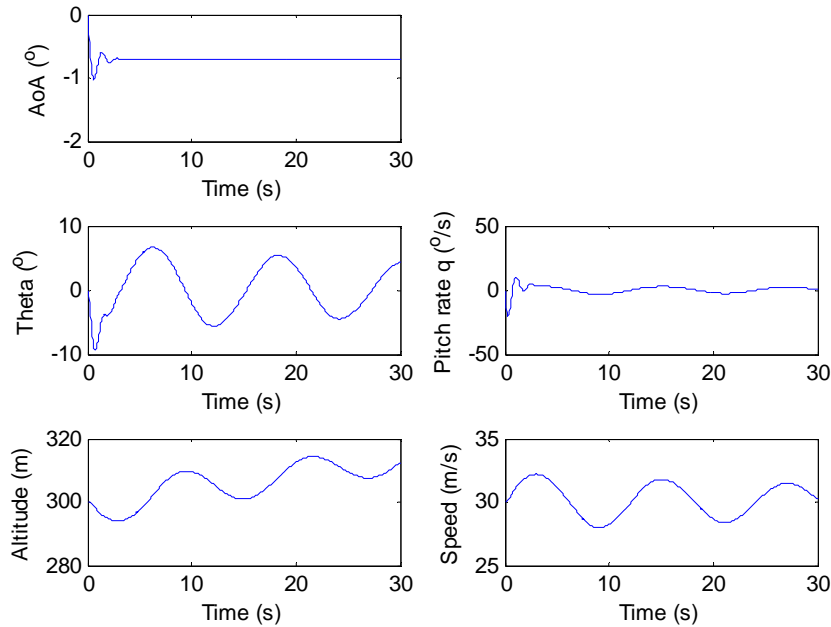

Figure 45. P10B longitudinal channel with 22% (10N) throttle increase

3. Change in Elevator Deflection

Figure 46. shows that with -1 degree elevator deflection, the UAV generates more lift. Thus the UAV's altitude increases. However, the deflection generates more drag that causes the speed to drop slightly.

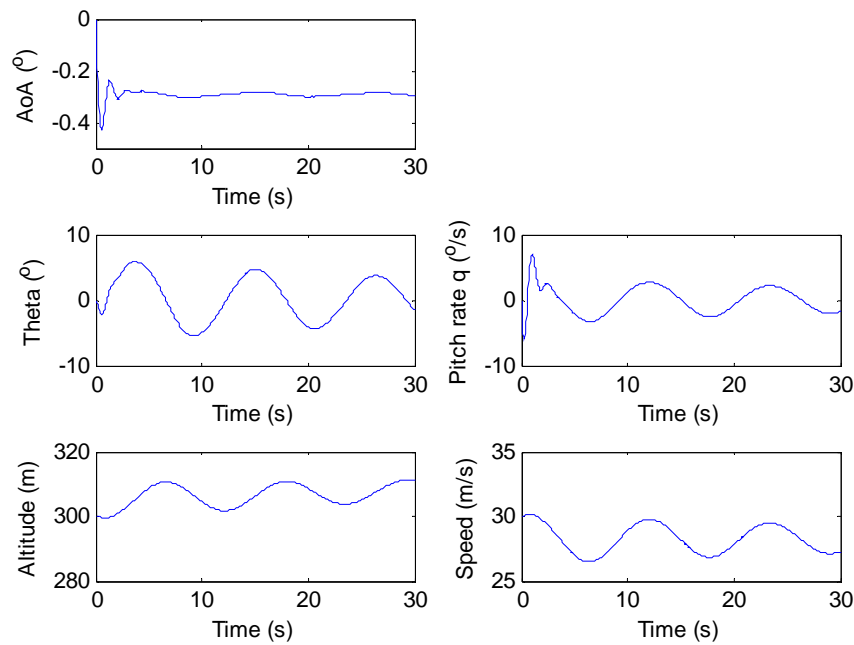

Figure 46. P10B longitudinal channel with 1 degree elevator deflection

4. Change in Aileron Deflection

Figure 47. shows that as aileron deflect, the UAV start to roll. The rolling of the UAV also causes the UAV to experience a certain yaw effect.

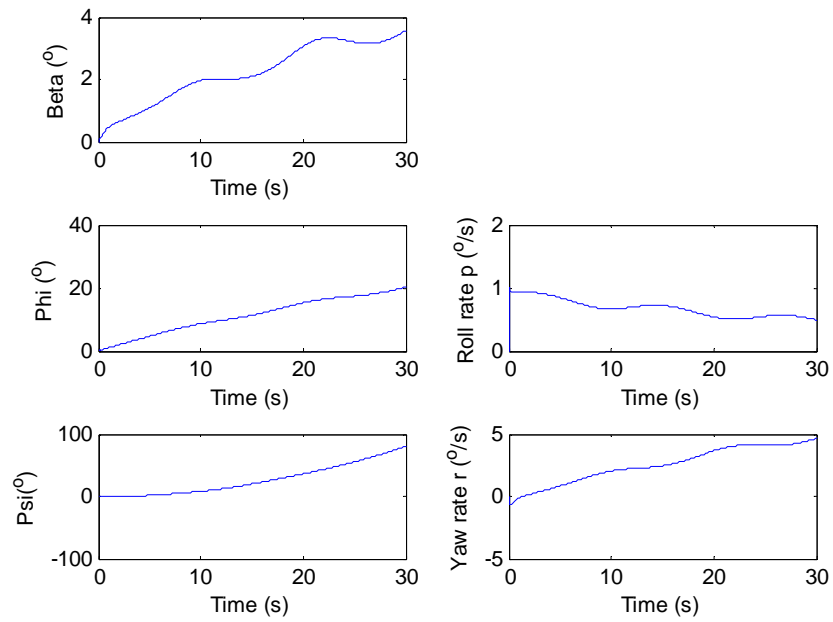

Figure 47. . P10B lateral channel with 1 degree aileron deflection

5. Change in Rudder Deflection

As the rudder deflect, the UAV yaw as shown in Figure 48. . At the same time, the UAV also experience roll effect.

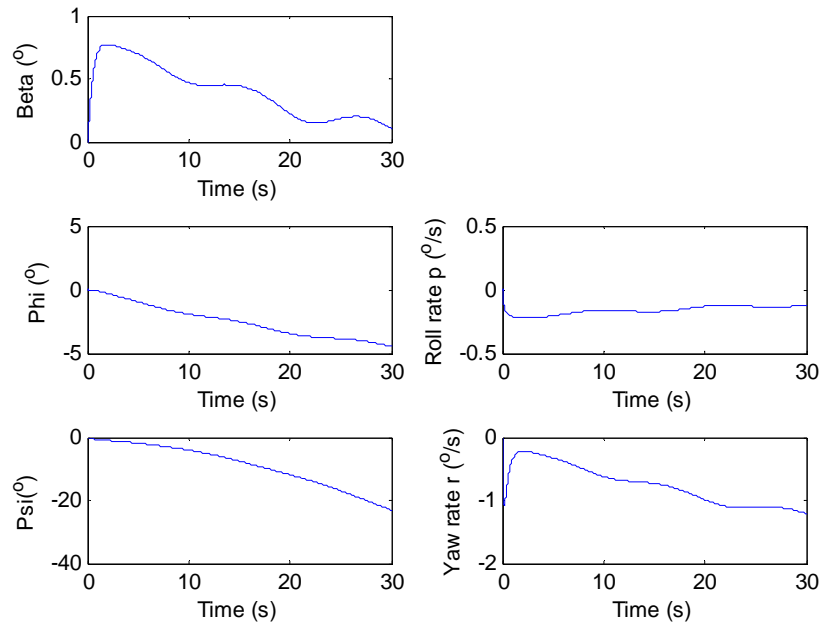

Figure 48. . P10B lateral channel with 1 degree rudder deflection

C. RASCAL SIMULATION RESULTS

The simulation result of the Rascal model is very similar to the P10B.

1. Trim Condition

Figure 49. shows that the longitudinal channel of the UAV at trim condition. It demonstrated an initial short period of disturbance that dies of in about 1 second. Following on is a long period of small oscillation. The magnitude of this oscillation is small, less than 10 meter for altitude. Figure 50. shows that the at trim condition, the horizontal channel of the UAV is constant at zero.

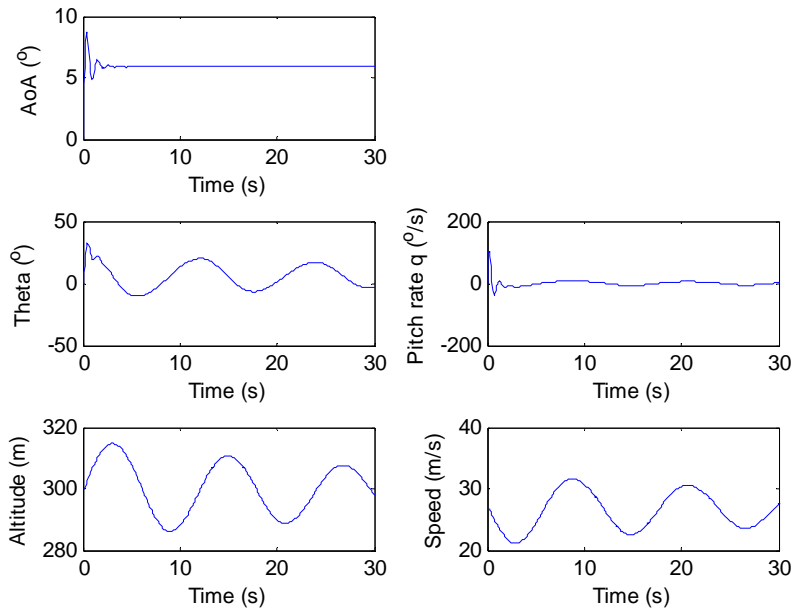

Figure 49. Rascal longitudinal channel at trim condition

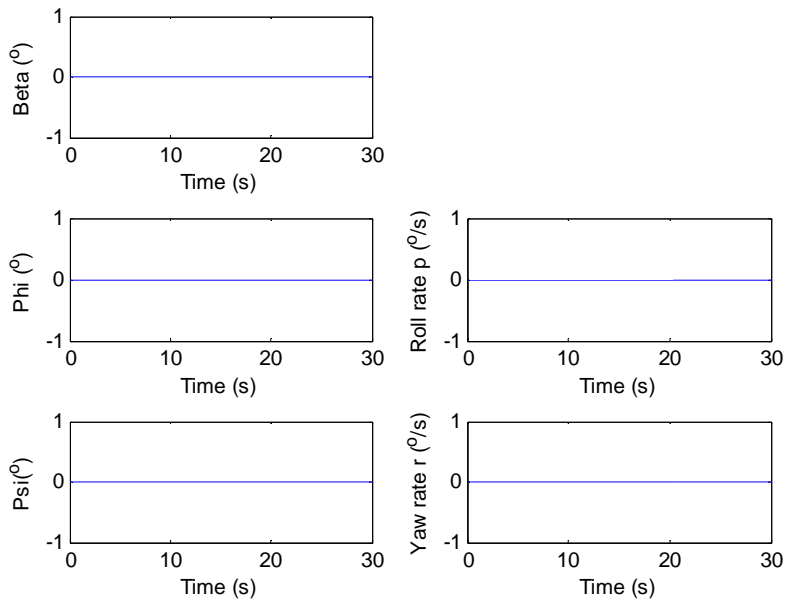

Figure 50. Rascal lateral channel at trim condition

2. Change in Thrust Parameter

A 1N additional thrust was introduced to the model. The UAV start to climb in altitude as a result of additional lift generated from the higher velocity, as shown in Figure 51. . The rest of the vertical channel does not change much.

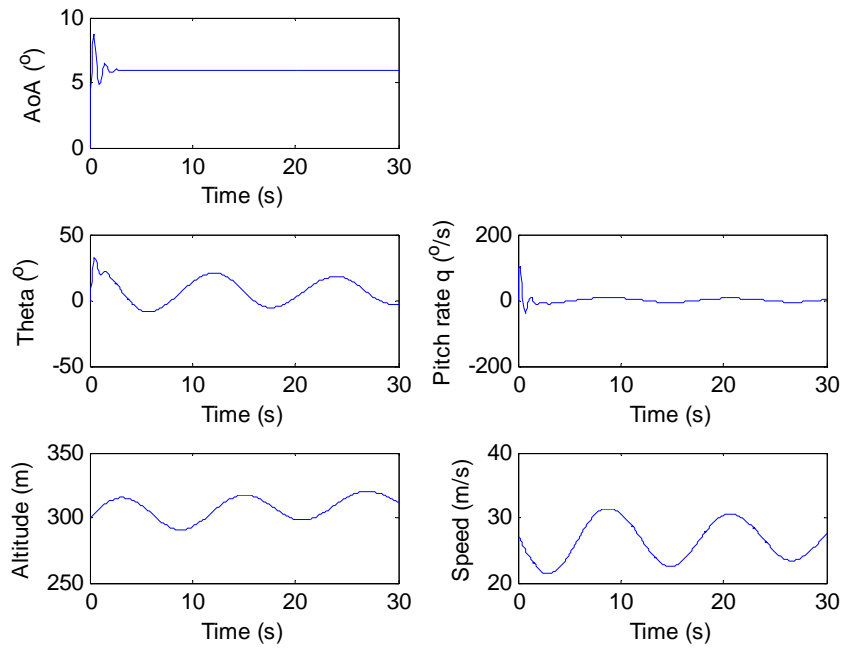

Figure 51. Rascal longitudinal channel with 21% (1N) throttle increase

3. Change in Elevator Deflection

Figure 52. shows that with -1 degree elevator deflection, the UAV generates more lift as the elevator deflect downwards. Therefore, the altitude increase and the speed drop due to increase drag.

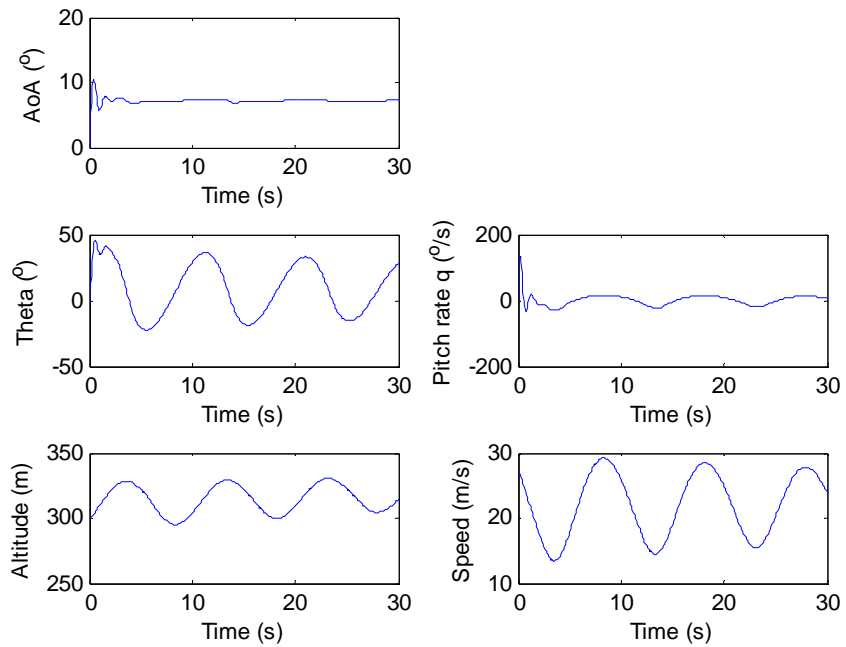

Figure 52. Rascal longitudinal channel with -1 degree elevator deflection

4. Change in Aileron Deflection

Figure 53. shows that as aileron deflect, the UAV start to roll. The rolling of the UAV also causes the UAV to experience a certain yaw effect.

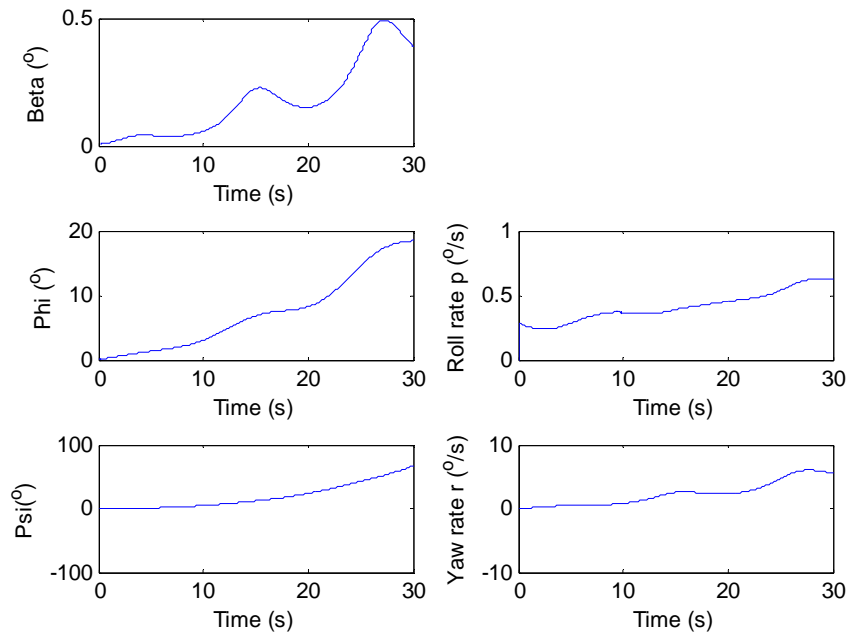

Figure 53. .Rascal lateral channel with 0.1 degree aileron deflection

5. Change in Rudder Deflection

As the rudder deflect, the UAV yaw as shown in Figure 54. . At the same time, the UAV also experience roll effect.

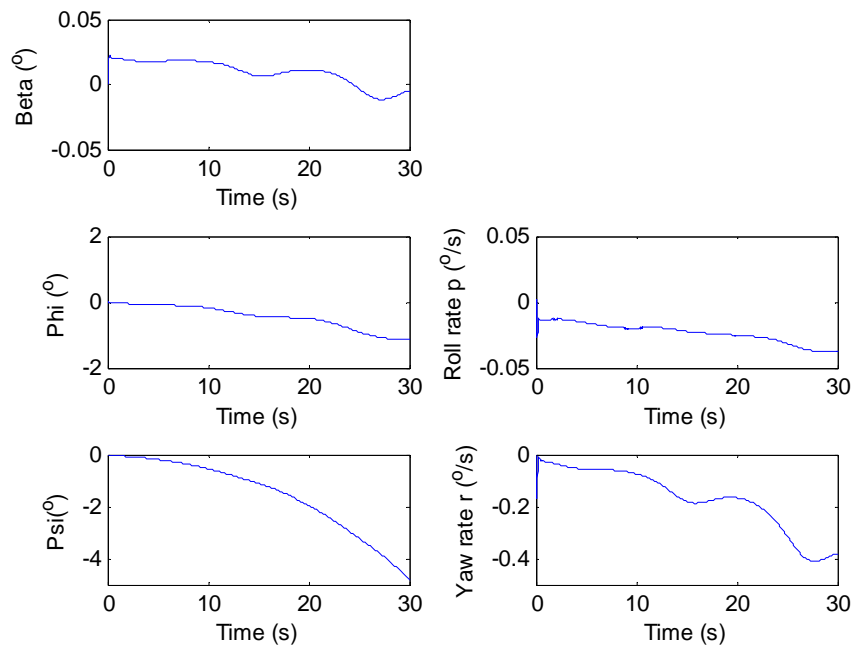

Figure 54. .Rascal lateral channel with 0.1 degree rudder deflection

V. DISCUSSION AND CONCLUSION

Various limitations were found during the modeling of the UAV in LinAir and AVL software. Following are listed the constraints and limitations of LinAir and AVL.

A. LINAIR LIMITATIONS AND CONSTRAINTS

The following were observed during the modeling in LinAir:

1. The number of panels for each element must be input into the system manually, but the number of panels cannot be determined before modeling. A “wrong” combination of numbers of panels for the elements will result in drastic errors in the output.
2. Knowledge of the control keys is necessary to control the software, i.e., “L” for moving left, “P” for pitch, etc.
3. The current version used does not support long filenames.
4. The software is unable to determine the drag vs. lift relationship for known airfoils. Conversion of airfoils into drag coefficients is required, and forms part of the input file.
5. When exporting the MS Excel model as an input file for LinAir, it was noted that the cell spacing of the Ms Excel worksheet has to be wide enough such that numbers would not be seen as joined together with the number in its neighbor cell. This is because the visual width of the MS Excel’s cell is equivalent to the spacing for the space delimited text file. Therefore, a cell full with numbers will appear merged with its neighbor cell after exporting.
6. The model created in LinAir is dimension independent. Either SI units or English units should be used throughout the input parameter. However, the same unit must be consistently used throughout the entire model.

7. Root to Tip direction must be in the positive direction of Y and Z axes for the horizontal and vertical plane respectively. i.e., the LE root is smaller than the LE tip. This means that the positive Y axis is toward the right side of the UAV (viewing from the rear of the UAV). Having an opposite sign convention will result in a negative force element while the CL vs. AOA remains normal.
8. The Nelem field is important, as LinAir determines the total number of elements from this field.
9. All elements of the same part should have the same drag coefficients.
10. It is better and easier to troubleshoot if fewer panels are defined for each element.
11. As far as possible, elements should not be stacked against each other along the X axis under the same surface, i.e., wing, vertical stabilizer, etc.
12. Every loading of the model will refresh the data file. Running of the simulation continuously without reloading will result in the output file being congested. It is recommended that the model be reloaded and data extracted at each interval before proceeding to the next configuration.

B. AVL LIMITATIONS AND CONSTRAINTS

The following were observed during the modeling in AVL:

1. AVL uses +X axes from the leading edge to the trailing edge of fuselage, and +Y axes from the left wing to the right wing, and +Z axis upwards.
2. AVLS have only circular fuselages. Non-circular fuselages are approximated using circular fuselage measurements. AVL's fuselage GUI is only able to create a fuselage with up to a length of 100 units. In order to overcome this constraint, the physical value is scaled down to below 100. Subsequently, the actual scale can be restored by indicating an equivalent upscale on the X, Y and Z scale value.

3. Similar to LinAir, the leading edge and trailing edge direction must be the same for joint parts such as left wing and right wing.
4. No drag information of the airfoil is required, as the system is able to accept airfoil geometry to determine the drag properties. Defining on NACA airfoil is done by simply entering the NACA number. AVL also allows import of other airfoil geometry by either manual entering for import form text file.
5. The AVL requires a much longer duration for each simulation run.
6. The total dimension for any axis must be less than 100 units. AVL GUI will output the data into a text file (refer to Appendix F) before activating the AVL program to obtain the data from the text file created. Having any dimension more than 100 units will result in this value merging with its neighboring value, and cause errors in the AVL program.
7. AVL is unable to create control surface with sudden increase in cord fraction, such as the case for the P10B and the rudder for Rascal.
8. AVL requires high processing power and/ or time.

C. CONCLUSION

Unfortunately AVL is unable to generate result for P10B and the coefficient generated for Rascal does not produce meaningful trim condition. As such, comparison between LinAir and AVL is not possible.

LinAir generated coefficient for both P10B and Rascal has generated satisfactory trim condition parameter, as well as simulation result.

However, LinAir is preferred over AVL based on the experience of using the software. This is due to the significant different in speed of the simulation and graphic user interface of the software.

THIS PAGE INTENTIONALLY LEFT BLANK

VI. RECOMMENDATION

The following research area are recommended for future work on aerodynamics derivative,

A. AVL

This research has not produce satisfactory result from AVL for comparison between LinAir and AVL. It is recommended to further evaluate the AVL software and it integration with Piccolo simulator.

B. VERIFICATION WITH ACTUAL DATA

In order to verify that the 6DOF model with the aerodynamic and control derivative is a good representative of the actual model, a comparison of the simulated path with an actual flight data may be performed.

C. FUTURE WORK ON P10B AND RASCAL

The result from this thesis on P10B and Rascal could be used in the controller design for these two UAV using Simluink model. The results could also be used in the Piccolo simulator to assess the flight quality of the UAV before actual flight.

THIS PAGE INTENTIONALLY LEFT BLANK

APPENDIX A. MATLAB SIMULINK INPUT FILE

A. P-10B SIMULINK MODEL INPUT FILE

```
clc;
T=0.05;
r_lim=7;
% Initial Conditions in ENU (all vector data is represented as a
column vectors)
Pos_0 = [-1000; -500.0; 300]'; % Initial position vector (m)
Vel_0 = [30.; 0; 0]'; % Initial velocity vector (m/s)
Euler_0 = [0; 0; 0]*pi/180; % Initial Euler angles (rad)
Omega_0 = [0; 0; 0]'; % Initial Omega
(rad/s)
PQR_0 = [0; 0; 0]'; % Initial Omega (rad/s)
Vb_0 = [30; 0; 0]'; % Initial body-velocity vector
(m/s)

% Mass and Geometric Parameters recomputation
S = 4.916119; % surface area of wing (m2)
span = 6.4516; % wingspan (m)
chord = S/span; % chord (m)
mass = 63; % gross weight (kg)
Ixx = 45; % main moment of inertia around axis Ox (kg*sq.m)
Iyy = 26; % main moment of inertia around axis Oy (kg*sq.m)
Izz = 61; % main moment of inertia around axis Oz (kg*sq.m)

% Aerodynamic Derivatives (all per radian)
CL0 = 0.2521; % lift coefficient at a = 0 = 0.0003;
CLa = 5.0420; % lift curve slope
CLa_dot = 4.8890; % lift due to angle of attack rate
CLq = 5.6436; % lift due to pitch rate
CLDe = 0.3621; % lift due to elevator
CD0 = 0.0129; % drag coefficient at a = 0
Apolars = 0.0774; % drag curve slope (A2)
A1 = 0.0004;
CYb = -0.2922; % side force due to sideslip
CYDr = 0.1587; % sideforce due to rudder
Clb = -0.1146; % dihedral effect =-0.0132
Clp = -4.0508; % roll damping
Clr = 0.3495; % roll due to yaw rate
ClDa = 0.4509; % roll control power
ClDr = 0.0052; % roll due to rudder
Cm0 = 0.0974; % pitch moment at a = 0 =>0.0652
Cma = -2.4694; % pitch moment due to angle of attack
Cma_dot = -2.0695; % pitch moment due to angle of attack rate
Cmq = -8.4569; % pitch moment due to pitch rate
CmDe = -1.0273; % pitch control power
Cnb = 0.0573; % weathercock stability = 0.075
Cnp = -0.2693; % adverse yaw
Cnr = -0.3782; % yaw damping
CnDa = -0.0045; % aileron adverse yaw
```

```

CnDr    = -0.0586;    % yaw control power
CLDf    = 0;         %
CmDf    = 0;
% Standard Atmosphere
ISA_lapse = .0065;    % Lapse rate          (degC/m)
ISA_hmax  = 2000;    % Altitude limit      (m)
ISA_R     = 287;     % Gas Constant       (degK*m*m/s/s)
ISA_g     = 9.815;   % Gravity            (m/s/s)
ISA_rho0  = 1.225;   % Density at sea level (kg/m/m/m)
ISA_P0    = 101325;  % Sea-level Pressure  (N/m/m)
ISA_T0    = 289;     % Sea-level Temperature (degK)

```

```

%%%%%%%%%%%%%%%%%%%%%%%%%%%%%%%%%%%%%%%%%%%%%%%%%%%%%%%%%%%%%%%%%%%%%%%%
% Load Wind Profile
%%%%%%%%%%%%%%%%%%%%%%%%%%%%%%%%%%%%%%%%%%%%%%%%%%%%%%%%%%%%%%%%%%%%%%%%
load YPGwind.mat;

```

B. RASCAL SIMULINK MODEL INPUT FILE

```

clc;
T=0.05;
r_lim=7;
% Initial Conditions in ENU (all vector data is represented as a
column vectors)
Pos_0    = [-1000; -500.0; 300]';    % Initial position vector (m)
%Vel_0    = [25.; 0; 0]';           % Initial velocity vector (m/s)
Euler_0   = [0; 0; 0]*pi/180;       % Initial Euler angles (rad)
Omega_0   = [0; 0; 0]';             % Initial Omega
(rad/s)
PQR_0     = [0; 0; 0]';             % Initial Omega (rad/s)
Vb_0     = [27; 0; 0]';             % Initial body-velocity vector
(m/s)

% Mass and Geometric Parameters recomputation
S        = 0.459528;                % surface area of wing (m2)
span     = 2.80416;                 % wingspan (m)
chord    = S/span;                  % chord (m)
mass     = 5.9;                      % gross weight (kg)
Ixx      = 0.8;                      % main moment of inertia around axis Ox (kg*sq.m)
Iyy      = 0.7;                      % main moment of inertia around axis Oy (kg*sq.m)
Izz      = 1.2;                      % main moment of inertia around axis Oz (kg*sq.m)

% Aerodynamic Derivatives (all per radian)
CL0      = 0.2115;                   % lift coefficient at a = 0 = 0.0003;
CLa      = 2.2403;                   % lift curve slope
CLa_dot  = 2.1963;                   % lift due to angle of attack rate
CLq      = 7.2479;                   % lift due to pitch rate
CLDe     = 0.6868;                   % lift due to elevator
CD0      = 0.0195;                   % drag coefficient at a = 0
Apolar   = 0.0195;                   % drag curve slope (A2)
Al       = -0.0049;
CYb      = -1.8449;                   % side force due to sideslip
CYDr     = 0.2021;                   % sideforce due to rudder

```



```

Clb      = -0.1490;      % dihedral effect ==-0.0132
Clp      = -3.1971;      % roll damping
Clr      = 0.4011;      % roll due to yaw rate
ClDa     = 0.4698;      % roll control power
ClDr     = 0.0103;      % roll due to rudder
Cm0      = 0.0237;      % pitch moment at a = 0 =>0.0652
Cma      = -3.4836;      % pitch moment due to angle of attack
Cma_dot  = -3.6114;      % pitch moment due to angle of attack rate
Cmq      = -13.2651;    % pitch moment due to pitch rate
CmDe     = -4.4135;      % pitch control power
Cnb      = 0.5500;      % weathercock stability = 0.075
Cnp      = -0.0974;      % adverse yaw
Cnr      = -0.7620;      % yaw damping
CnDa     = -0.0019;      % aileron adverse yaw
CnDr     = -0.1220;      % yaw control power
CLDf     = 0;           %
CmDf     = 0;           %
% Standard Atmosphere
ISA_lapse = .0065;      % Lapse rate           (degC/m)
ISA_hmax  = 2000;      % Altitude limit       (m)
ISA_R     = 287;       % Gas Constant         (degK*m*m/s/s)
ISA_g     = 9.815;     % Gravity              (m/s/s)
ISA_rho0  = 1.225;     % Density at sea level (kg/m/m/m)
ISA_P0    = 101325;    % Sea-level Pressure   (N/m/m)
ISA_T0    = 289;       % Sea-level Temperature (degK)

%%%%%%%%%%%%%%%%%%%%%%%%%%%%%%%%%%%%%%%%%%%%%%%%%%%%%%%%%%%%%%%%%%%%%%%%
% Load Wind Profile
%%%%%%%%%%%%%%%%%%%%%%%%%%%%%%%%%%%%%%%%%%%%%%%%%%%%%%%%%%%%%%%%%%%%%%%%
load YPGwind.mat;

```

THIS PAGE INTENTIONALLY LEFT BLANK

APPENDIX B GRAPHICAL UAV MODELS

A. P-10B MODEL

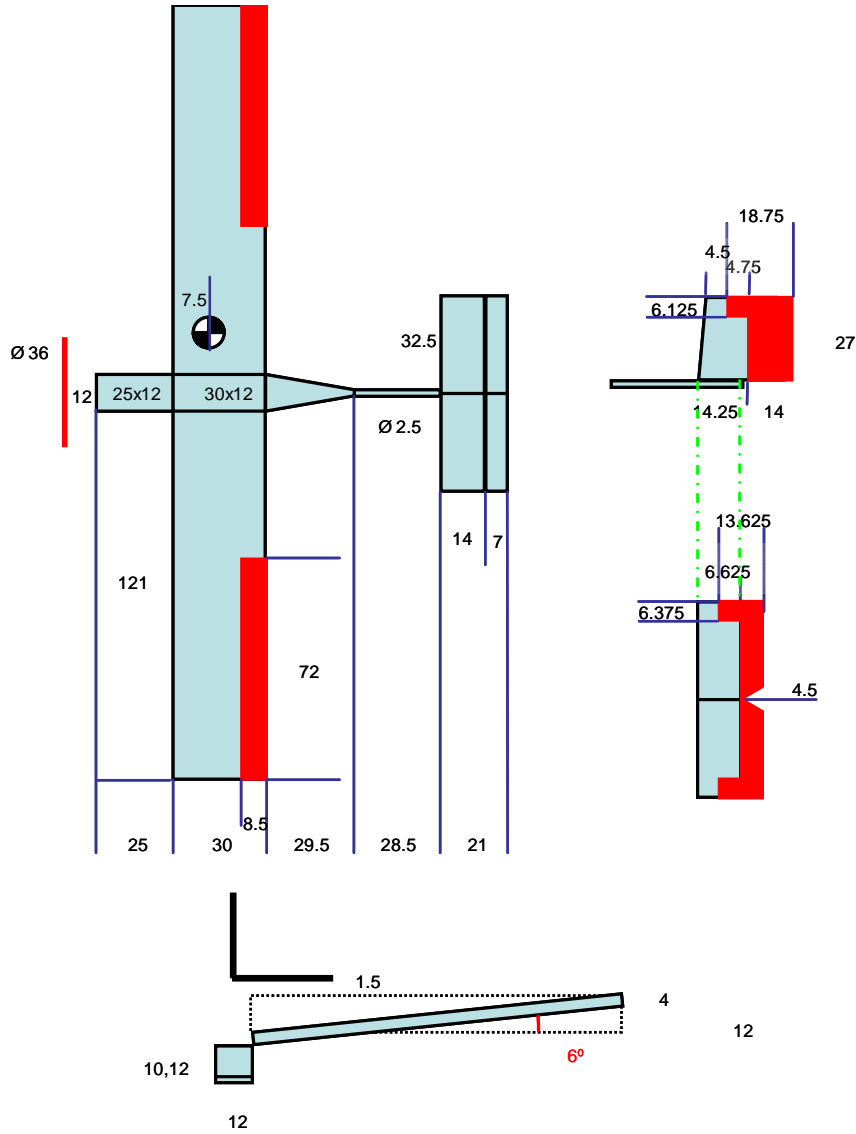

Figure 55. P-10B Model

B. RASCAL MODEL

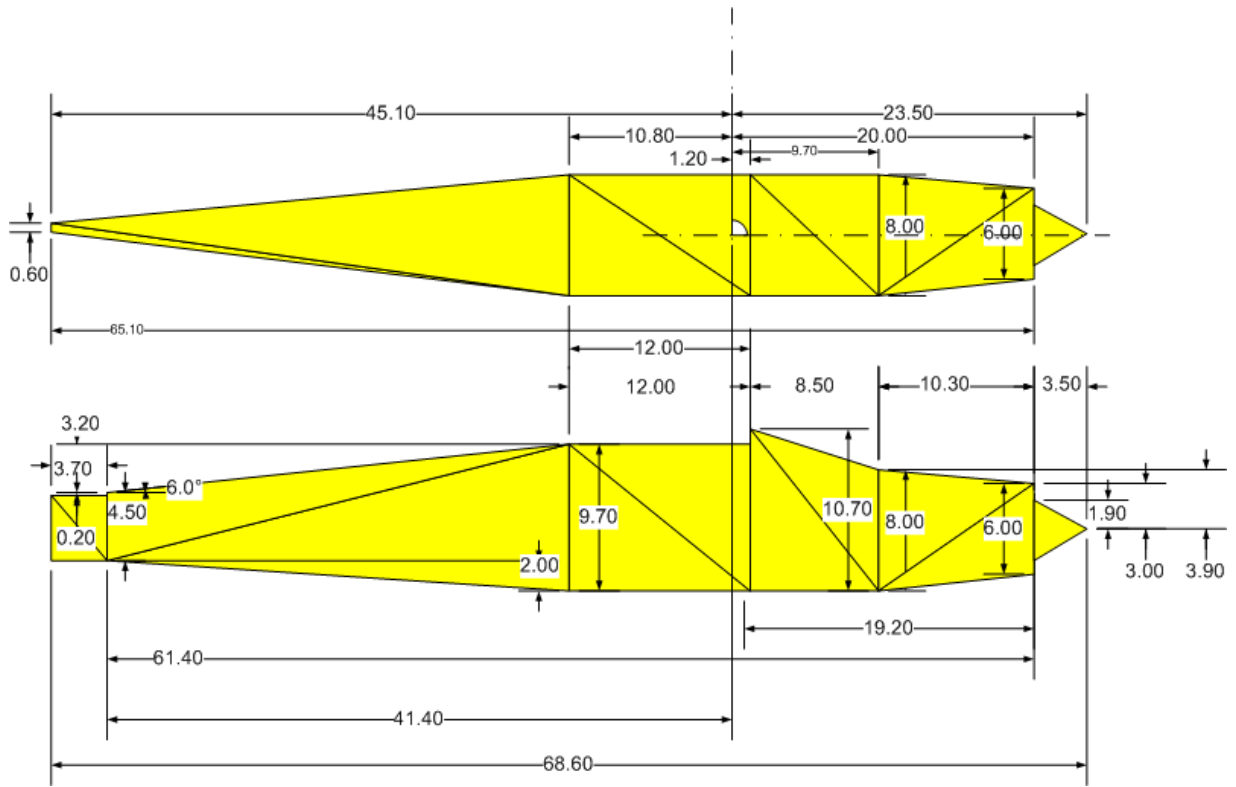

Figure 56. MS Visio model for Fuselage

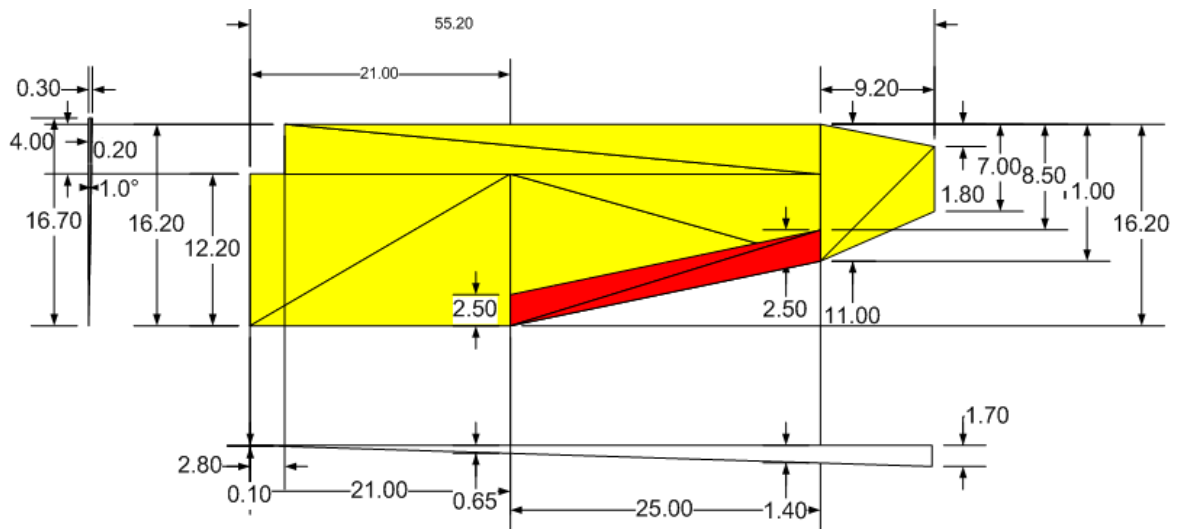
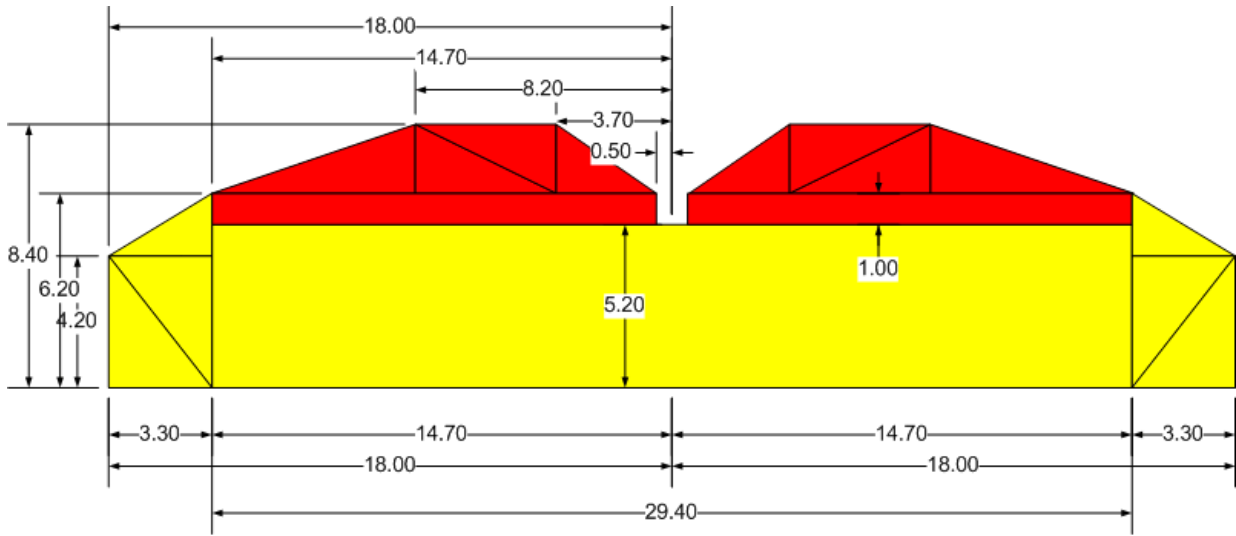

Figure 57. MS Visio model for Wing and Aileron



(64.9,0,2.40)

Figure 58. MS Visio model for horizontal stabilizer and Elevator

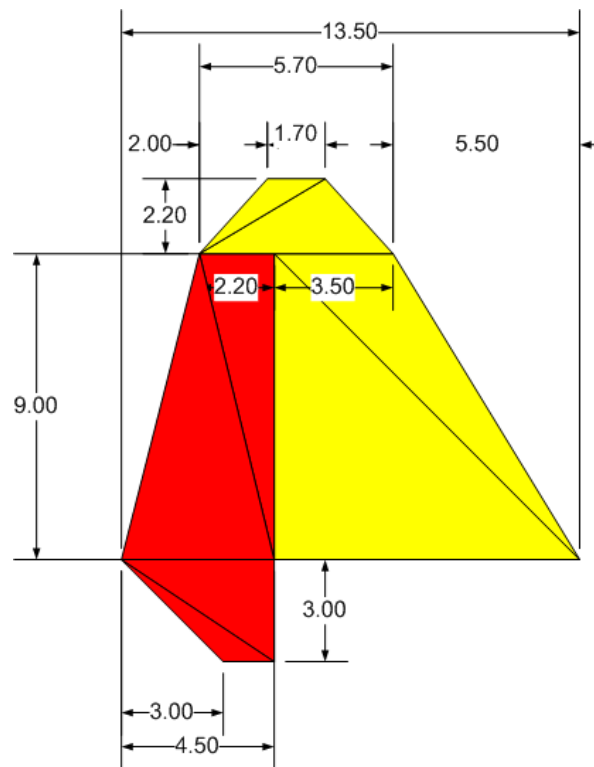

Figure 59. MS Visio model for Vertical Stabilizer and Rudder

THIS PAGE INTENTIONALLY LEFT BLANK

```

! Element 4.0000 Fuselase Horizontal1/3
! XrootLE YrootLE ZrootLE XrootTE YrootTE ZrootTE
! -32.5000 -6.0000 0.0000 22.5000 -6.0000 0.0000
! XtipLE YtipLE ZtipLE XtipTE YtipTE ZtipTE
! -32.5000 6.0000 0.0000 22.5000 6.0000 0.0000
! Number of Spanwise panels
! 2.0000
! CD0 CD1 CD2 Cmac CLmax
! 0.0035 0.0000 0.0000 0.0000 1.4000

! Element 5.0000 Fuselase Horizontal2/3
! XrootLE YrootLE ZrootLE XrootTE YrootTE ZrootTE
! 22.5000 -6.0000 0.0000 52.0000 -1.2500 0.0000
! XtipLE YtipLE ZtipLE XtipTE YtipTE ZtipTE
! 22.5000 6.0000 0.0000 52.0000 1.2500 0.0000
! Number of Spanwise panels
! 3.0000
! CD0 CD1 CD2 Cmac CLmax
! 0.0035 0.0000 0.0000 0.0000 1.4000

! Element 6.0000 Fuselase Horizontal3/3
! XrootLE YrootLE ZrootLE XrootTE YrootTE ZrootTE
! 52.0000 -1.2500 0.0000 94.5000 -1.2500 0.0000
! XtipLE YtipLE ZtipLE XtipTE YtipTE ZtipTE
! 52.0000 1.2500 0.0000 94.5000 1.2500 0.0000
! Number of Spanwise panels
! 4.0000
! CD0 CD1 CD2 Cmac CLmax
! 0.0035 0.0000 0.0000 0.0000 1.4000

! Element 7.0000 Left Wing 1/2
! XrootLE YrootLE ZrootLE XrootTE YrootTE ZrootTE
! -7.5000 -126.3371 18.6479 14.0000 -126.3371 18.6479
! XtipLE YtipLE ZtipLE XtipTE YtipTE ZtipTE
! -7.5000 -54.7316 16.0347 14.0000 -54.7316 16.0347
! Number of Spanwise panels
! 2.0000
! CD0 CD1 CD2 Cmac CLmax
! 0.0100 0.0000 0.0418 0.0000 1.4000

! Element 8.0000 Left Wing 2/2
! XrootLE YrootLE ZrootLE XrootTE YrootTE ZrootTE
! -7.5000 -54.7316 16.0347 22.5000 -54.7316 16.0347
! XtipLE YtipLE ZtipLE XtipTE YtipTE ZtipTE
! -7.5000 -6.0000 6.0000 22.5000 -6.0000 6.0000
! Number of Spanwise panels
! 4.0000
! CD0 CD1 CD2 Cmac CLmax
! 0.0100 0.0000 0.0418 0.0000 1.4000

! Element 9.0000 Right Wing 1/2
! XrootLE YrootLE ZrootLE XrootTE YrootTE ZrootTE
! -7.5000 6.0000 6.0000 22.5000 6.0000 6.0000
! XtipLE YtipLE ZtipLE XtipTE YtipTE ZtipTE

```



```

-7.5000  54.7316  16.0347  22.5000  54.7316  16.0347
! Number of Spanwise panels
! CD0 CD1 CD2 Cmac CLmax
! 0.0100 0.0000 0.0418 0.0000 1.4000

! Element 10.0000 Right Wing 2/2
! XrootLE YrootLE ZrootLE XrootTE YrootTE ZrootTE
! -7.5000 54.7316 16.0347 14.0000 54.7316 16.0347
! XtipLE YtipLE ZtipLE XtipTE YtipTE ZtipTE
! -7.5000 126.3371 18.6479 14.0000 126.3371 18.6479
! Number of Spanwise panels
! 2.0000
! CD0 CD1 CD2 Cmac CLmax
! 0.0100 0.0000 0.0418 0.0000 1.4000

! Element 11.0000 Left Aileron
! XrootLE YrootLE ZrootLE XrootTE YrootTE ZrootTE
! 14.0000 -126.3371 18.6479 22.5000 -126.3371 18.6479
! XtipLE YtipLE ZtipLE XtipTE YtipTE ZtipTE
! 14.0000 -54.7316 16.0347 22.5000 -54.7316 16.0347
! Number of Spanwise panels
! 2.0000
! CD0 CD1 CD2 Cmac CLmax
! 0.0100 0.0000 0.0418 0.0000 1.4000

! Element 12.0000 Right Aileron
! XrootLE YrootLE ZrootLE XrootTE YrootTE ZrootTE
! 14.0000 54.7316 16.0347 22.5000 54.7316 16.0347
! XtipLE YtipLE ZtipLE XtipTE YtipTE ZtipTE
! 14.0000 126.3371 18.6479 22.5000 126.3371 18.6479
! Number of Spanwise panels
! 2.0000
! CD0 CD1 CD2 Cmac CLmax
! 0.0100 0.0000 0.0418 0.0000 1.4000

! Element 13.0000 Horizontal Stabilize1/2
! XrootLE YrootLE ZrootLE XrootTE YrootTE ZrootTE
! 80.5000 -32.5000 1.2500 88.1250 -32.5000 1.2500
! XtipLE YtipLE ZtipLE XtipTE YtipTE ZtipTE
! 80.5000 32.5000 1.2500 88.1250 32.5000 1.2500
! Number of Spanwise panels
! 4.0000
! CD0 CD1 CD2 Cmac CLmax
! 0.0090 0.0000 0.0706 0.0000 1.4000

! Element 14.0000 Horizontal Stabilize2/2
! XrootLE YrootLE ZrootLE XrootTE YrootTE ZrootTE
! 88.1250 -26.1250 1.2500 94.7500 -26.1250 1.2500
! XtipLE YtipLE ZtipLE XtipTE YtipTE ZtipTE
! 88.1250 26.1250 1.2500 94.7500 26.1250 1.2500
! Number of Spanwise panels
! 4.0000
! CD0 CD1 CD2 Cmac CLmax
! 0.0090 0.0000 0.0706 0.0000 1.4000

```

!	Element	15.0000	Left Elevator	1/2		
!	XrootLE	YrootLE	ZrootLE	XrootTE	YrootTE	ZrootTE
	88.1250	-32.5000	1.2500	101.7500	-32.5000	1.2500
!	XtipLE	YtipLE	ZtipLE	XtipTE	YtipTE	ZtipTE
	88.1250	-26.1250	1.2500	101.7500	-26.1250	1.2500
!	Number	of	Spanwise	panels		
	2.0000					
!	CD0	CD1	CD2	Cmac	CLmax	
	0.0090	0.0000	0.0706	0.0000	1.4000	
!	Element	16.0000	Left Elevator	2/2		
!	XrootLE	YrootLE	ZrootLE	XrootTE	YrootTE	ZrootTE
	94.7500	-26.1250	1.2500	101.7500	-26.1250	1.2500
!	XtipLE	YtipLE	ZtipLE	XtipTE	YtipTE	ZtipTE
	94.7500	0.0000	1.2500	101.7500	-4.5000	1.2500
!	Number	of	Spanwise	panels		
	2.0000					
!	CD0	CD1	CD2	Cmac	CLmax	
	0.0090	0.0000	0.0706	0.0000	1.4000	
!	Element	17.0000	Right Elevator	1/2		
!	XrootLE	YrootLE	ZrootLE	XrootTE	YrootTE	ZrootTE
	94.7500	0.0000	1.2500	101.7500	4.5000	1.2500
!	XtipLE	YtipLE	ZtipLE	XtipTE	YtipTE	ZtipTE
	94.7500	26.1250	1.2500	101.7500	26.1250	1.2500
!	Number	of	Spanwise	panels		
	2.0000					
!	CD0	CD1	CD2	Cmac	CLmax	
	0.0090	0.0000	0.0706	0.0000	1.4000	
!	Element	18.0000	Right Elevator	2/2		
!	XrootLE	YrootLE	ZrootLE	XrootTE	YrootTE	ZrootTE
	88.1250	26.1250	1.2500	101.7500	26.1250	1.2500
!	XtipLE	YtipLE	ZtipLE	XtipTE	YtipTE	ZtipTE
	88.1250	32.5000	1.2500	101.7500	32.5000	1.2500
!	Number	of	Spanwise	panels		
	2.0000					
!	CD0	CD1	CD2	Cmac	CLmax	
	0.0090	0.0000	0.0706	0.0000	1.4000	
!	Element	19.0000	Vertical Stabilizer	1/2		
!	XrootLE	YrootLE	ZrootLE	XrootTE	YrootTE	ZrootTE
	80.5000	0.0000	1.2500	94.7500	0.0000	1.2500
!	XtipLE	YtipLE	ZtipLE	XtipTE	ZtipTE	ZtipTE
	84.3657	0.0000	22.1250	94.7500	0.0000	22.1250
!	Number	of	Spanwise	panels		
	4.0000					
!	CD0	CD1	CD2	Cmac	CLmax	
	0.0090	0.0000	0.0706	0.0000	1.4000	
!	Element	20.0000	Vertical Stabilizer	2/2		
!	XrootLE	YrootLE	ZrootLE	XrootTE	YrootTE	ZrootTE
	84.3657	0.0000	22.1250	88.8657	0.0000	22.1250
!	XtipLE	YtipLE	ZtipLE	XtipTE	YtipTE	ZtipTE

```

      85.5000    0.0000    28.2500    88.8657    0.0000    28.2500
!      Number    of      Spanwise panels
      2.0000
!      CD0      CD1      CD2      Cmac      CLmax
      0.0090    0.0000    0.0706    0.0000    1.4000

!      Element    21.0000    Rudder      1/2
!      XrootLE    YrootLE    ZrootLE    XrootTE    YrootTE    ZrootTE
      94.7500    0.0000    1.2500    108.7500    0.0000    1.2500
!      XtipLE     YtipLE     ZtipLE     XtipTE     YtipTE     ZtipTE
      94.7500    0.0000    22.1250    108.7500    0.0000    22.1250
!      Number    of      Spanwise panels
      4.0000
!      CD0      CD1      CD2      Cmac      CLmax
      0.0090    0.0000    0.0706    0.0000    1.4000

!      Element    22.0000    Rudder      108.7500    2/2
20.13426
!      XrootLE    YrootLE    ZrootLE    XrootTE    YrootTE    ZrootTE
      88.8657    0.0000    22.1250    108.7500    0.0000    22.1250
!      XtipLE     YtipLE     ZtipLE     XtipTE     YtipTE     ZtipTE
      88.8657    0.0000    28.2500    108.7500    0.0000    28.2500
!      Number    of      Spanwise panels
      4.0000
!      CD0      CD1      CD2      Cmac      CLmax
      0.0090    0.0000    0.0706    0.0000    1.4000

end

```

	0.00352	0	0	0	1.4	
!	Element 5 Fuselase Vertical 5/6					
!	XrootLE	YrootLE	ZrootLE	XrootTE	YrootTE	ZrootTE
	10.8	0	6.7	39.9	0	2.4
!	XtipLE	YtipLE	ZtipLE	XtipTE	YtipTE	ZtipTE
	10.8	0	-4	39.9	0	-2.1
!	Number	of	Spanwise	panels		
	3					
!	CD0	CD1	CD2	Cmac	CLmax	
	0.00352	0	0	0	1.4	
!	Element 6 Fuselase Vertical 6/6					
!	XrootLE	YrootLE	ZrootLE	XrootTE	YrootTE	ZrootTE
	39.9	0	2.4	45.1	0	2.4
!	XtipLE	YtipLE	ZtipLE	XtipTE	YtipTE	ZtipTE
	39.9	0	-2.1	45.1	0	-2.1
!	Number	of	Spanwise	panels		
	7					
!	CD0	CD1	CD2	Cmac	CLmax	
	0.00352	0	0	0	1.4	
!	Element 7 Fuselase Horizontal 1/5					
!	XrootLE	YrootLE	ZrootLE	XrootTE	YrootTE	ZrootTE
	-23.5	0	0	-20	1.9	0
!	XtipLE	YtipLE	ZtipLE	XtipTE	YtipTE	ZtipTE
	-23.5	0	0	-20	-1.9	0
!	Number	of	Spanwise	panels		
	2					
!	CD0	CD1	CD2	Cmac	CLmax	
	0.00352	0	0	0	1.4	
!	Element 8 Fuselase Horizontal 2/5					
!	XrootLE	YrootLE	ZrootLE	XrootTE	YrootTE	ZrootTE
	-20	3	0	-9.7	4	0
!	XtipLE	YtipLE	ZtipLE	XtipTE	YtipTE	ZtipTE
	-20	-3	0	-9.7	-4	0
!	Number	of	Spanwise	panels		
	3					
!	CD0	CD1	CD2	Cmac	CLmax	
	0.00352	0	0	0	1.4	
!	Element 9 Fuselase Horizontal 3/5					
!	XrootLE	YrootLE	ZrootLE	XrootTE	YrootTE	ZrootTE
	-9.7	4	0	-1.2	4	0
!	XtipLE	YtipLE	ZtipLE	XtipTE	YtipTE	ZtipTE
	-9.7	-4	0	-1.2	-4	0
!	Number	of	Spanwise	panels		
	4					
!	CD0	CD1	CD2	Cmac	CLmax	
	0.00352	0	0	0	1.4	
!	Element 10 Fuselase Horizontal 4/5					
!	XrootLE	YrootLE	ZrootLE	XrootTE	YrootTE	ZrootTE
	-1.2	4	0	10.8	4	0

!	XtipLE	YtipLE	ZtipLE	XtipTE	YtipTE	ZtipTE
	-1.2	-4	0	10.8	-4	0
!	Number	of	Spanwise	panels		
	5					
!	CD0	CD1	CD2	Cmac	CLmax	
	0.00352	0	0	0	1.4	
!	Element 11	Fuselase	Horizontal	5/5		
!	XrootLE	YrootLE	ZrootLE	XrootTE	YrootTE	ZrootTE
	10.8	4	0	45.1	0.6	0
!	XtipLE	YtipLE	ZtipLE	XtipTE	YtipTE	ZtipTE
	10.8	-4	0	45.1	-0.6	0
!	Number	of	Spanwise	panels		
	3					
!	CD0	CD1	CD2	Cmac	CLmax	
	0.00352	0	0	0	1.4	
!	Element 12	Right Wing		1/4		
!	XrootLE	YrootLE	ZrootLE	XrootTE	YrootTE	ZrootTE
	-1.2	0	6.9	11	0	6.7
!	XtipLE	YtipLE	ZtipLE	XtipTE	YtipTE	ZtipTE
	-1.2	-21	7.55	11	-21	7.35
!	Number	of	Spanwise	panels		
	3					
!	CD0	CD1	CD2	Cmac	CLmax	
	0.01	0	0.020668746	0	1.4	
!	Element 13	Right Wing		2/4		
!	XrootLE	YrootLE	ZrootLE	XrootTE	YrootTE	ZrootTE
	-5.2	-2.8	7.1	-1.2	-2.8	7
!	XtipLE	YtipLE	ZtipLE	XtipTE	YtipTE	ZtipTE
	-5.2	-46	8.4	-1.2	-46	8.3
!	Number	of	Spanwise	panels		
	4					
!	CD0	CD1	CD2	Cmac	CLmax	
	0.000033	0.0002	0.0043	0	1.4	
!	Element 14	Right Wing		3/4		
!	XrootLE	YrootLE	ZrootLE	XrootTE	YrootTE	ZrootTE
	-1.2	-21	7.55	8.5	-21	7.4
!	XtipLE	YtipLE	ZtipLE	XtipTE	YtipTE	ZtipTE
	-1.2	-46	8.3	4.3	-46	8.23
!	Number	of	Spanwise	panels		
	4					
!	CD0	CD1	CD2	Cmac	CLmax	
	0.000033	0.0002	0.0043	0	1.4	
!	Element 15	Right Wing		4/4		
!	XrootLE	YrootLE	ZrootLE	XrootTE	YrootTE	ZrootTE
	-5.2	-46	8.4	6.8	-46	8.2
!	XtipLE	YtipLE	ZtipLE	XtipTE	YtipTE	ZtipTE
	-3.4	-55.2	8.65	1.8	-55.2	8.57
!	Number	of	Spanwise	panels		
	4					
!	CD0	CD1	CD2	Cmac	CLmax	

	0.000033	0.0002	0.0043	0	1.4	
!	Element 16 Left Wing			1/4		
!	XrootLE	YrootLE	ZrootLE	XrootTE	YrootTE	ZrootTE
	-1.2	21	7.55	11	21	7.35
!	XtipLE	YtipLE	ZtipLE	XtipTE	YtipTE	ZtipTE
	-1.2	0	6.9	11	0	6.7
!	Number	of	Spanwise	panels		
	3					
!	CD0	CD1	CD2	Cmac	CLmax	
	0.000033	0.0002	0.0043	0	1.4	
!	Element 17 Left Wing			2/4		
!	XrootLE	YrootLE	ZrootLE	XrootTE	YrootTE	ZrootTE
	-5.2	46	8.4	-1.2	46	8.3
!	XtipLE	YtipLE	ZtipLE	XtipTE	YtipTE	ZtipTE
	-5.2	2.8	7.1	-1.2	2.8	7
!	Number	of	Spanwise	panels		
	4					
!	CD0	CD1	CD2	Cmac	CLmax	
	0.000033	0.0002	0.0043	0	1.4	
!	Element 18 Left Wing			3/4		
!	XrootLE	YrootLE	ZrootLE	XrootTE	YrootTE	ZrootTE
	-1.2	46	8.3	4.3	46	8.23
!	XtipLE	YtipLE	ZtipLE	XtipTE	YtipTE	ZtipTE
	-1.2	21	7.55	8.5	21	7.4
!	Number	of	Spanwise	panels		
	4					
!	CD0	CD1	CD2	Cmac	CLmax	
	0.000033	0.0002	0.0043	0	1.4	
!	Element 19 Left Wing			4/4		
!	XrootLE	YrootLE	ZrootLE	XrootTE	YrootTE	ZrootTE
	-3.4	55.2	8.65	1.8	55.2	8.57
!	XtipLE	YtipLE	ZtipLE	XtipTE	YtipTE	ZtipTE
	-5.2	46	8.4	6.8	46	8.2
!	Number	of	Spanwise	panels		
	4					
!	CD0	CD1	CD2	Cmac	CLmax	
	0.000033	0.0002	0.0043	0	1.4	
!	Element 20 Right Aileron					
!	XrootLE	YrootLE	ZrootLE	XrootTE	YrootTE	ZrootTE
	8.5	-21	7.4	11	-21	7.35
!	XtipLE	YtipLE	ZtipLE	XtipTE	ZtipTE	ZtipTE
	4.3	-46	8.23	6.8	-46	8.2
!	Number	of	Spanwise	panels		
	4					
!	CD0	CD1	CD2	Cmac	CLmax	
	0.000033	0.0002	0.0043	0	1.4	
!	Element 21 Left Aileron					
!	XrootLE	YrootLE	ZrootLE	XrootTE	YrootTE	ZrootTE
	4.3	46	8.23	6.8	46	8.2

!	XtipLE	YtipLE	ZtipLE	XtipTE	YtipTE	ZtipTE
	8.5	21	7.4	11	21	7.35
!	Number	of	Spanwise	panels		
	4					
!	CD0	CD1	CD2	Cmac	CLmax	
	0.000033	0.0002	0.0043	0	1.4	
!	Element 22	Horizontal Stabilizer		1/3		
!	XrootLE	YrootLE	ZrootLE	XrootTE	YrootTE	ZrootTE
	39.9	-14.7	2.4	45.1	-14.7	2.4
!	XtipLE	YtipLE	ZtipLE	XtipTE	YtipTE	ZtipTE
	39.9	14.7	2.4	45.1	14.7	2.4
!	Number	of	Spanwise	panels		
	4					
!	CD0	CD1	CD2	Cmac	CLmax	
	0.009	0	0.070637286	0	1.4	
!	Element 23	Horizontal Stabilizer		2/3		
!	XrootLE	YrootLE	ZrootLE	XrootTE	YrootTE	ZrootTE
	39.9	-18	2.4	44.1	-18	2.4
!	XtipLE	YtipLE	ZtipLE	XtipTE	YtipTE	ZtipTE
	39.9	-14.7	2.4	46.1	-14.7	2.4
!	Number	of	Spanwise	panels		
	4					
!	CD0	CD1	CD2	Cmac	CLmax	
	0.009	0	0.070637286	0	1.4	
!	Element 24	Horizontal Stabilizer		3/3		
!	XrootLE	YrootLE	ZrootLE	XrootTE	YrootTE	ZrootTE
	39.9	14.7	2.4	46.1	14.7	2.4
!	XtipLE	YtipLE	ZtipLE	XtipTE	YtipTE	ZtipTE
	39.9	18	2.4	44.1	18	2.4
!	Number	of	Spanwise	panels		
	4					
!	CD0	CD1	CD2	Cmac	CLmax	
	0.009	0	0.070637286	0	1.4	
!	Element 25	Left Elevator		1/2		
!	XrootLE	YrootLE	ZrootLE	XrootTE	YrootTE	ZrootTE
	45.1	14.7	2.4	46.1	14.7	2.4
!	XtipLE	YtipLE	ZtipLE	XtipTE	YtipTE	ZtipTE
	45.1	0.5	2.4	46.1	0.5	2.4
!	Number	of	Spanwise	panels		
	4					
!	CD0	CD1	CD2	Cmac	CLmax	
	0.009	0	0.070637286	0	1.4	
!	Element 26	Left Elevator		2/2		
!	XrootLE	YrootLE	ZrootLE	XrootTE	YrootTE	ZrootTE
	46.1	14.7	2.4	48.3	8.2	2.4
!	XtipLE	YtipLE	ZtipLE	XtipTE	YtipTE	ZtipTE
	46.1	0.5	2.4	48.3	3.7	2.4
!	Number	of	Spanwise	panels		
	4					
!	CD0	CD1	CD2	Cmac	CLmax	

	0.009	0	0.070637286	0	1.4	
!	Element 27 Right Elevator			1/2		
!	XrootLE	YrootLE	ZrootLE	XrootTE	YrootTE	ZrootTE
	45.1	-0.5	2.4	46.1	-0.5	2.4
!	XtipLE	YtipLE	ZtipLE	XtipTE	YtipTE	ZtipTE
	45.1	-14.7	2.4	46.1	-14.7	2.4
!	Number	of	Spanwise	panels		
	4					
!	CD0	CD1	CD2	Cmac	CLmax	
	0.009	0	0.070637286	0	1.4	
!	Element 28 Right Elevator			2/2		
!	XrootLE	YrootLE	ZrootLE	XrootTE	YrootTE	ZrootTE
	46.1	-0.5	2.4	48.3	-3.7	2.4
!	XtipLE	YtipLE	ZtipLE	XtipTE	YtipTE	ZtipTE
	46.1	-14.7	2.4	48.3	-8.2	2.4
!	Number	of	Spanwise	panels		
	4					
!	CD0	CD1	CD2	Cmac	CLmax	
	0.009	0	0.070637286	0	1.4	
!	Element 29 Vertical Stabilizer			1/2		
!	XrootLE	YrootLE	ZrootLE	XrootTE	YrootTE	ZrootTE
	36.1	0	2.4	45.1	0	2.4
!	XtipLE	YtipLE	ZtipLE	XtipTE	ZtipTE	ZtipTE
	41.6	0	11.4	45.1	0	11.4
!	Number	of	Spanwise	panels		
	4					
!	CD0	CD1	CD2	Cmac	CLmax	
	0.009	0	0.070637286	0	1.4	
!	Element 30 Vertical Stabilizer			2/2		
!	XrootLE	YrootLE	ZrootLE	XrootTE	YrootTE	ZrootTE
	41.6	0	11.4	47.3	0	11.4
!	XtipLE	YtipLE	ZtipLE	XtipTE	YtipTE	ZtipTE
	43.6	0	13.6	45.3	0	13.6
!	Number	of	Spanwise	panels		
	4					
!	CD0	CD1	CD2	Cmac	CLmax	
	0.009	0	0.070637286	0	1.4	
!	Element 31 Rudder			1/2		
!	XrootLE	YrootLE	ZrootLE	XrootTE	YrootTE	ZrootTE
	45.1	0	2.4	49.6	0	2.4
!	XtipLE	YtipLE	ZtipLE	XtipTE	ZtipTE	ZtipTE
	45.1	0	11.4	47.3	0	11.4
!	Number	of	Spanwise	panels		
	4					
!	CD0	CD1	CD2	Cmac	CLmax	
	0.009	0	0.070637286	0	1.4	
!	Element 32 Rudder			2/2		
!	XrootLE	YrootLE	ZrootLE	XrootTE	YrootTE	ZrootTE
	45.1	0	-0.6	46.6	0	-0.6

```
!      XtipLE      YtipLE      ZtipLE      XtipTE      YtipTE      ZtipTE
      45.1         0          2.4         49.6         0           2.4
!      Number      of          Spanwise    panels
      4
!      CD0         CD1         CD2         Cmac         CLmax
      0.009        0          0.070637286  0           1.4
end
```

APPENDIX D: SIMULINK TRIM COMMAND

These command takes input from both the P10B and Rascal inout file to compute the trim condition for each UAV.

```
%% Determine steady-state trim parameters

clc, V=norm(Vb_0); df=0;

ro=1.225*(1-0.0065*Pos_0(3)/288.15)^4.25589;

atrim = (CmDe*CL0*S*V^2*ro+CmDe*CLDf*df*S*V^2*ro-2*CmDe*mass*ISA_g-
CLDe*S*V^2*ro*Cm0-CLDe*S*V^2*ro*CmDf*df)/S/ro/V^2/(-CLa*CmDe+Cma*CLDe);
detrим = -(Cma*CL0*S*V^2*ro+Cma*CLDf*df*S*V^2*ro-2*Cma*mass*ISA_g-
CLa*S*V^2*ro*Cm0-CLa*S*V^2*ro*CmDf*df)/S/ro/V^2/(-CLa*CmDe+Cma*CLDe);

atrim=atrim*180/pi

detrим=detrим*180/pi

CLtrim=mass*ISA_g/(S*ro*V^2/2);

Thrusttrim=(CD0+A1*CLtrim+Apolar*CLtrim^2)*S*ro*V^2/2
dthrottle=Thrusttrim/244.5
```

THIS PAGE INTENTIONALLY LEFT BLANK

APPENDIX E: AVL INPUT FORMAT

A sample file for an RC glider is shown below. Comment lines begin with a "#". Everything after and including a "!" is ignored. Blank lines are ignored.

```
# SuperGee

#

# Dimensional unit and parameter data.

# Mass & Inertia breakdown.

# Names and scalings for units to be used for trim and eigenmode calculations.

# The Lunit and Munit values scale the mass, xyz, and inertia table data below.

# Lunit value will also scale all lengths and areas in the AVL input file.

Lunit = 0.0254 m

Munit = 0.001 kg

Tunit = 1.0 s

#-----

# Gravity and density to be used as default values in trim setup (saves runtime
typing).

# Must be in the unit names given above (i.e. m,kg,s).

g = 9.81

rho = 1.225

#-----

# Mass & Inertia breakdown.

# x y z is location of item's own CG.
```

```

# Ixx... are item's inertias about item's own CG.

#

# x,y,z system here must be exactly the same one used in the .avl input file

# (same orientation, same origin location, same length units)

#

# mass x y z Ixx Iyy Izz [ Ixy Ixz Iyz ]
* 1. 1. 1. 1. 1. 1. 1. 1. 1.
+ 0. 0. 0. 0. 0. 0. 0. 0. 0.

58.0 3.34 12.0 1.05 4400 180 4580 ! right wing
58.0 3.34 -12.0 1.05 4400 180 4580 ! left wing
16.0 -5.2 0.0 0.0 0 80 80 ! fuselage pod
18.0 13.25 0.0 0.0 0 700 700 ! boom+rods
22.0 -7.4 0.0 0.0 0 0 0 ! battery
2.0 -2.5 0.0 0.0 0 0 0 ! jack
9.0 -3.8 0.0 0.0 0 0 0 ! RX
9.0 -5.1 0.0 0.0 0 0 0 ! rud servo
6.0 -5.9 0.0 0.0 0 0 0 ! ele servo
9.0 2.6 1.0 0.0 0 0 0 ! R wing servo
9.0 2.6 -1.0 0.0 0 0 0 ! L wing servo
2.0 1.0 0.0 0.5 0 0 0 ! wing connector
1.0 3.0 0.0 0.0 0 0 0 ! wing pins
6.0 29.0 0.0 1.0 70 2 72 ! stab
6.0 33.0 0.0 2.0 35 39 4 ! rudder
0.0 -8.3 0.0 0.0 0 0 0 ! nose wt.

```

Units

The first three lines give the magnitudes and names of the units to be used for run case setup and possibly for eigenmode calculations.

- Lunit = 0.0254 m
- Munit = 0.001 kg
- Tunit = 1.0 s

In this example, standard SI units (m,kg,s) are chosen. But the data in xxx.avl and xxx.mass is given in units of Lunit = 1 inch, which is therefore declared here to be equal to "0.0254 m". If the data was given in centimeters, the statement would read, "Lunit = 0.01 m", and if it was given directly in meters, it would read, "Lunit = 1.0 m"

Similarly, Munit used here in this file is the gram, but since the kilogram (kg) is to be used for run case calculations, the Munit declaration is, "Munit = 0.001 kg". If the masses here were given in ounces, the declaration would be, "Munit = 0.02835 kg". The third line gives the time unit name and magnitude. If any of the three unit lines is absent, that unit's magnitude will be set to 1.0, and the unit name will simply remain as "Lunit", "Munit", or "Tunit"

THIS PAGE INTENTIONALLY LEFT BLANK

APPENDIX F: AVL INPUT FILE

A. P-10B MODEL

```
*****
# AVL dataset for Untitled Aircraft model
# Generated by AVL Model Editor on 28 Oct 2008
*****
Untitled Aircraft
#Mach
  0.0920
#IYsym    IZsym    Zsym
  0        0        0.0000
#Sref     Cref     Bref
#@Auto-generate
  1815.0000 15.0000 121.0000

*****
# AVL Axes:
# +X    downstream
# +Y    out right wing
# +Z    up
*****

#Xref     Yref     Zref
0.0000    0.0000    2.5775
#CDp
0.0000

*****
# Surfaces
*****

#=====Wing=====
SURFACE
Wing
#Nchord   Cspace   Nspan    Sspace
  12       2.0000   64       0.0000

SCALE
#sX       sY        sZ
  1.0000   1.0000   1.0000

TRANSLATE
#dX       dY        dZ
 -3.7500   0.0000   3.0000

ANGLE
```

```
#Ainc
0.0000
```

```
#=====Wing section 1=====
```

```
SECTION
#Xle      Yle      Zle      Chord    Angle
0.0000   -60.5000  0.0000   15.0000  3.5000
```

```
AFILE
#Airfoil definition
clarky.txt
```

```
CLAF
#CLaf = CLalpha / (2 * pi)
1.0000
```

```
CONTROL
#label      gain      Xhinge    Xhvec     Yhvec     Zhvec     SgnDup
LeftAileron -1.0000   0.7167    0.0000    0.0000    0.0000    0.0000    1
```

```
#=====Wing section 2=====
```

```
SECTION
#Xle      Yle      Zle      Chord    Angle
0.0000   -48.0000  0.0000   15.0000  3.5000
```

```
AFILE
#Airfoil definition
clarky.txt
```

```
CLAF
#CLaf = CLalpha / (2 * pi)
1.0000
```

```
CONTROL
#label      gain      Xhinge    Xhvec     Yhvec     Zhvec     SgnDup
LeftAileron -1.0000   0.7167    0.0000    0.0000    0.0000    0.0000    1
```

```
#=====Wing section 3=====
```

```
SECTION
#Xle      Yle      Zle      Chord    Angle
0.0000    0.0000   0.0000   15.0000  3.5000
```

```
AFILE
#Airfoil definition
clarky.txt
```

```
CLAF
#CLaf = CLalpha / (2 * pi)
1.0000
```

```
#=====Wing section 4=====
```

```

SECTION
#Xle      Yle      Zle      Chord   Angle
 0.0000   48.0000  0.0000  15.0000 3.5000

AFILE
#Airfoil definition
  clarky.txt

CLAF
#CLaf = CLalpha / (2 * pi)
  1.0000

CONTROL
#label      gain      Xhinge   Xhvec    Yhvec    Zhvec    SgnDup
RightAileron -1.0000  0.7167   0.0000   0.0000   0.0000   0.0000   1

#-----Wing section 5-----
SECTION
#Xle      Yle      Zle      Chord   Angle
 0.0000   60.5000  0.0000  15.0000 3.5000

AFILE
#Airfoil definition
  clarky.txt

CLAF
#CLaf = CLalpha / (2 * pi)
  1.0000

CONTROL
#label      gain      Xhinge   Xhvec    Yhvec    Zhvec    SgnDup
RightAileron -1.0000  0.7167   0.0000   0.0000   0.0000   0.0000   1

#-----Horizontal-----
#@Yduplicate 3 0.00000 Horizontal
SURFACE
RHorizontal
#Nchord   Cspace   Nspan    Sspace
  12       2.0000   32       0.0000

SCALE
#sX      sY      sZ
  1.0000  1.0000  1.0000

TRANSLATE
#dX      dY      dZ
 40.2500  0.0000  0.6250

ANGLE
#Ainc
  0.0000

INDEX

```

#Lsurf
1

#=====Horizontal section 1=====

SECTION

#Xle	Yle	Zle	Chord	Angle
0.0000	16.2500	0.0000	10.5000	0.0000

NACA

#Airfoil definition
0008

CONTROL

#label	gain	Xhinge	Xhvec	Yhvec	Zhvec	SgnDup
#@Basename Elevator						
RElevator	-1.0000	0.3512	14.0000	0.0000	0.0000	1

#=====Horizontal section 2=====

SECTION

#Xle	Yle	Zle	Chord	Angle
0.0000	13.0625	0.0000	10.5000	0.0000

NACA

#Airfoil definition
0008

CONTROL

#label	gain	Xhinge	Xhvec	Yhvec	Zhvec	SgnDup
#@Basename Elevator						
RElevator	-1.0000	0.6667	0.0000	0.0000	0.0000	-1

#=====Horizontal section 3=====

SECTION

#Xle	Yle	Zle	Chord	Angle
0.0000	0.0000	0.0000	10.5000	0.0000

NACA

#Airfoil definition
0008

CONTROL

#label	gain	Xhinge	Xhvec	Yhvec	Zhvec	SgnDup
#@Basename New						
LNew	-1.0000	0.6667	0.6667	0.0000	0.0000	-1

CONTROL

#label	gain	Xhinge	Xhvec	Yhvec	Zhvec	SgnDup
#@Ignore						
RNew	-1.0000	0.6667	0.6667	0.0000	0.0000	-1

#=====Horizontal (mirror)=====

```

#@Ignore
SURFACE
LHorizontal
#Nchord   Cspace   Nspan   Sspace
  12      2.0000  32      0.0000

SCALE
#sX      sY      sZ
  1.0000  1.0000  1.0000

TRANSLATE
#dX      dY      dZ
  40.2500 0.0000  0.6250

ANGLE
#Ainc
  0.0000

INDEX
#Lsurf
  1

#====Horizontal section 4====
SECTION
#Xle      Yle      Zle      Chord   Angle
  0.0000  0.0000  0.0000  10.5000 0.0000

NACA
#Airfoil definition
  0008

CONTROL
#label    gain     Xhinge   Xhvec   Yhvec   Zhvec   SgnDup
#@Baseline New
  LNew    -1.0000  0.6667  0.6667  0.0000  0.0000  -1

CONTROL
#label    gain     Xhinge   Xhvec   Yhvec   Zhvec   SgnDup
#@Ignore
  RNew    -1.0000  0.6667  0.6667  0.0000  0.0000  -1

#====Horizontal section 5====
SECTION
#Xle      Yle      Zle      Chord   Angle
  0.0000  -13.0625 0.0000  10.5000 0.0000

NACA
#Airfoil definition
  0008

CONTROL
#label    gain     Xhinge   Xhvec   Yhvec   Zhvec   SgnDup
#@Baseline Elevator

```

LElevator -1.0000 0.6667 0.0000 0.0000 0.0000 -1

#=====Horizontal section 6=====

SECTION

#Xle Yle Zle Chord Angle
0.0000 -16.2500 0.0000 10.5000 0.0000

NACA

#Airfoil definition
0008

CONTROL

#label gain Xhinge Xhvec Yhvec Zhvec SgnDup
#@Basename Elevator
LElevator -1.0000 0.3512 14.0000 0.0000 0.0000 1

#=====Vertical=====

#@Yduplicate 3 0.00000 Vertical

SURFACE

RVertical

#Nchord Cspace Nspan Sspace
12 2.0000 32 0.0000

SCALE

#sX sY sZ
1.0000 1.0000 1.0000

TRANSLATE

#dX dY dZ
40.2500 0.0000 0.0000

ANGLE

#Ainc
0.0000

INDEX

#Lsurf
2

#=====Vertical section 1=====

SECTION

#Xle Yle Zle Chord Angle
0.0000 0.5000 0.6250 14.1250 0.0000

NACA

#Airfoil definition
0008

CONTROL

#label gain Xhinge Xhvec Yhvec Zhvec SgnDup
#@Basename New
RNew 0.0000 0.5044 0.0000 0.0000 0.0000 -1

#=====Vertical section 2=====

SECTION

#Xle	Yle	Zle	Chord	Angle
2.1829	0.0000	11.0625	12.1921	0.0000

NACA

#Airfoil definition
0008

CONTROL

#label	gain	Xhinge	Xhvec	Yhvec	Zhvec	SgnDup
#@Basename New						
LNew	0.0000	0.4932	0.0000	0.0000	0.0000	-1

CONTROL

#label	gain	Xhinge	Xhvec	Yhvec	Zhvec	SgnDup
#@Ignore						
RNew	0.0000	0.4932	0.0000	0.0000	0.0000	-1

#=====Vertical section 3=====

SECTION

#Xle	Yle	Zle	Chord	Angle
2.7500	0.0000	14.1250	11.6750	0.0000

NACA

#Airfoil definition
0008

CONTROL

#label	gain	Xhinge	Xhvec	Yhvec	Zhvec	SgnDup
#@Basename New						
LNew	0.0000	0.1935	0.0000	0.0000	0.0000	-1

CONTROL

#label	gain	Xhinge	Xhvec	Yhvec	Zhvec	SgnDup
#@Ignore						
RNew	0.0000	0.1935	0.0000	0.0000	0.0000	-1

#=====Vertical (mirror)=====

#@Ignore

SURFACE

LVertical

#Nchord	Cspace	Nspan	Sspace
12	2.0000	32	0.0000

SCALE

#sX	sY	sZ
1.0000	1.0000	1.0000

TRANSLATE

#dX	dY	dZ
-----	----	----

40.2500 0.0000 0.0000

ANGLE
#Ainc
0.0000

INDEX
#Lsurf
2

#=====Vertical section 4=====

SECTION
#Xle Yle Zle Chord Angle
2.7500 0.0000 14.1250 11.6750 0.0000

NACA
#Airfoil definition
0008

CONTROL
#label gain Xhinge Xhvec Yhvec Zhvec SgnDup
#@Basename New
LNew 0.0000 0.1935 0.0000 0.0000 0.0000 -1

CONTROL
#label gain Xhinge Xhvec Yhvec Zhvec SgnDup
#@Ignore
RNew 0.0000 0.1935 0.0000 0.0000 0.0000 -1

#=====Vertical section 5=====

SECTION
#Xle Yle Zle Chord Angle
2.1829 0.0000 11.0625 12.1921 0.0000

NACA
#Airfoil definition
0008

CONTROL
#label gain Xhinge Xhvec Yhvec Zhvec SgnDup
#@Basename New
LNew 0.0000 0.4932 0.0000 0.0000 0.0000 -1

CONTROL
#label gain Xhinge Xhvec Yhvec Zhvec SgnDup
#@Ignore
RNew 0.0000 0.4932 0.0000 0.0000 0.0000 -1

#=====Vertical section 6=====

SECTION
#Xle Yle Zle Chord Angle
0.0000 -0.5000 0.6250 14.1250 0.0000

```

NACA
#Airfoil definition
  0008

CONTROL
#label      gain      Xhinge   Xhvec    Yhvec    Zhvec    SgnDup
#@Basename New
  LNew      0.0000   0.5044   0.0000   0.0000   0.0000   -1

#*****
# Bodies
#*****

#=====P10B=====
BODY
P10B
#Nbody      Bspace
  15         2.0000

SCALE
#sX          sY          sZ
  1.0000     1.0000     1.0000

TRANSLATE
#dX          dY          dZ
 -22.2500   0.0000     0.0000

BFILE
#Body file
  P10B.dat

```

B. RASCAL MODEL

```
*****
# AVL dataset for Rascal model
# Generated by AVL Model Editor on 2 Nov 2008
*****
Rascal
#Mach
  0.0588
#IYsym    IZsym    Zsym
  0        0        0.0000
#Sref     Cref     Bref
#@Auto-generate
  1509.440013.6725  110.4000

*****
# AVL Axes:
# +X    downstream
# +Y    out right wing
# +Z    up
*****

#Xref     Yref     Zref
0.0000    0.0000    0.0000
#CDp
0.0000

*****
# Surfaces
*****

#=====HorizontalStabiliser=====
#@Yduplicate 5 0.00000 HorizontalStabiliser
SURFACE
RHorizontalStabiliser
#Nchord   Cspace   Nspan   Sspace
  12       2.0000   32      0.0000

SCALE
#sX       sY       sZ
  1.0000   1.0000   1.0000

TRANSLATE
#dX       dY       dZ
  41.4000  0.0000   1.5000

ANGLE
#Ainc
  0.0000
```

INDEX
#Lsurf
1

#=====HorizontalStabiliser section 1=====

SECTION

#Xle	Yle	Zle	Chord	Angle
0.0000	0.0000	0.0000	6.2000	0.0000

CONTROL

#label	gain	Xhinge	Xhvec	Yhvec	Zhvec	SgnDup
#@Basename Elevator						
LElevator	0.0000	0.8387	0.0000	0.0000	0.0000	1

CONTROL

#label	gain	Xhinge	Xhvec	Yhvec	Zhvec	SgnDup
#@Ignore						
RElevator	0.0000	0.8387	0.0000	0.0000	0.0000	1

#=====HorizontalStabiliser section 2=====

SECTION

#Xle	Yle	Zle	Chord	Angle
0.0000	3.7000	0.0000	8.4000	0.0000

CONTROL

#label	gain	Xhinge	Xhvec	Yhvec	Zhvec	SgnDup
#@Basename Elevator						
RElevator	0.0000	0.6190	0.0000	0.0000	0.0000	1

#=====HorizontalStabiliser section 3=====

SECTION

#Xle	Yle	Zle	Chord	Angle
0.0000	8.2000	0.0000	8.4000	0.0000

CONTROL

#label	gain	Xhinge	Xhvec	Yhvec	Zhvec	SgnDup
#@Basename Elevator						
RElevator	0.0000	0.6190	0.0000	0.0000	0.0000	1

#=====HorizontalStabiliser section 4=====

SECTION

#Xle	Yle	Zle	Chord	Angle
0.0000	14.7000	0.0000	6.2000	0.0000

CONTROL

#label	gain	Xhinge	Xhvec	Yhvec	Zhvec	SgnDup
#@Basename Elevator						
RElevator	0.0000	0.8387	0.0000	0.0000	0.0000	1

#=====HorizontalStabiliser section 5=====

```

SECTION
#Xle      Yle      Zle      Chord    Angle
 0.0000   18.0000  0.0000   4.2000   0.0000

#====HorizontalStabiliser (mirror)=====
#@Ignore
SURFACE
LHorizontalStabiliser
#Nchord   Cspace   Nspan    Sspace
 12       2.0000   32       0.0000

SCALE
#sX       sY       sZ
 1.0000   1.0000   1.0000

TRANSLATE
#dX       dY       dZ
 41.4000  0.0000   1.5000

ANGLE
#Ainc
 0.0000

INDEX
#Lsurf
 1

#====HorizontalStabiliser section 6=====
SECTION
#Xle      Yle      Zle      Chord    Angle
 0.0000   -18.0000 0.0000   4.2000   0.0000

#====HorizontalStabiliser section 7=====
SECTION
#Xle      Yle      Zle      Chord    Angle
 0.0000   -14.7000 0.0000   6.2000   0.0000

CONTROL
#label    gain     Xhinge   Xhvec    Yhvec    Zhvec    SgnDup
#@Basename Elevator
LElevator 0.0000  0.8387  0.0000  0.0000  0.0000  1

#====HorizontalStabiliser section 8=====
SECTION
#Xle      Yle      Zle      Chord    Angle
 0.0000   -8.2000  0.0000  8.4000  0.0000

CONTROL
#label    gain     Xhinge   Xhvec    Yhvec    Zhvec    SgnDup
#@Basename Elevator
LElevator 0.0000  0.6190  0.0000  0.0000  0.0000  1

```

#=====HorizontalStabiliser section 9=====

SECTION

#Xle	Yle	Zle	Chord	Angle
0.0000	-3.7000	0.0000	8.4000	0.0000

CONTROL

#label	gain	Xhinge	Xhvec	Yhvec	Zhvec	SgnDup
#@Basename Elevator						
LElevator	0.0000	0.6190	0.0000	0.0000	0.0000	1

#=====HorizontalStabiliser section 10=====

SECTION

#Xle	Yle	Zle	Chord	Angle
0.0000	0.0000	0.0000	6.2000	0.0000

CONTROL

#label	gain	Xhinge	Xhvec	Yhvec	Zhvec	SgnDup
#@Basename Elevator						
LElevator	0.0000	0.8387	0.0000	0.0000	0.0000	1

CONTROL

#label	gain	Xhinge	Xhvec	Yhvec	Zhvec	SgnDup
#@Ignore						
RElevator	0.0000	0.8387	0.0000	0.0000	0.0000	1

#=====VerticalStabiliser=====

SURFACE

VerticalStabiliser

#Nchord	Cspace	Nspan	Sspace
12	2.0000	64	0.0000

SCALE

#sX	sY	sZ
1.0000	1.0000	1.0000

TRANSLATE

#dX	dY	dZ
46.6000	0.0000	1.5000

ANGLE

#Ainc
0.0000

#=====VerticalStabiliser section 1=====

SECTION

#Xle	Yle	Zle	Chord	Angle
0.0000	0.0000	-3.0000	1.5000	0.0000

CONTROL

#label	gain	Xhinge	Xhvec	Yhvec	Zhvec	SgnDup
--------	------	--------	-------	-------	-------	--------

```

Rudder    0.0000    0.0001    0.0000    0.0000    0.0000    1

#=====VerticalStabiliser section 2=====
SECTION
#Xle      Yle      Zle      Chord    Angle
-9.0000   0.0000   0.0000   13.5000  0.0000

CONTROL
#label    gain     Xhinge   Xhvec    Yhvec    Zhvec    SgnDup
Rudder    0.0000   0.6667   0.0000   0.0000   0.0000   1

#=====VerticalStabiliser section 3=====
SECTION
#Xle      Yle      Zle      Chord    Angle
-3.5000   0.0000   9.0000   5.7000   0.0000

CONTROL
#label    gain     Xhinge   Xhvec    Yhvec    Zhvec    SgnDup
Rudder    0.0000   0.6140   0.0000   0.0000   0.0000   1

#=====VerticalStabiliser section 4=====
SECTION
#Xle      Yle      Zle      Chord    Angle
-1.5000   0.0000   11.2000  1.7000   0.0000

#=====Wing=====
SURFACE
Wing
#Nchord   Cspace   Nspan    Sspace
12        2.0000   64       0.0000

SCALE
#sX       sY       sZ
1.0000    1.0000   1.0000

TRANSLATE
#dX       dY       dZ
0.0000    0.0000   5.3500

ANGLE
#Ainc
0.0000

#=====Wing section 1=====
SECTION
#Xle      Yle      Zle      Chord    Angle
1.8000    -55.2000 1.7000   5.2000   1.0000

NACA
#Airfoil definition

```

2312

#=====Wing section 2=====

SECTION

#Xle	Yle	Zle	Chord	Angle
0.0000	-46.0000	1.4000	11.0000	1.0000

NACA

#Airfoil definition

2312

CONTROL

#label	gain	Xhinge	Xhvec	Yhvec	Zhvec	SgnDup
LeftAileron	0.0000	0.7727	0.0000	0.0000	0.0000	1

#=====Wing section 3=====

SECTION

#Xle	Yle	Zle	Chord	Angle
0.0000	-21.0000	0.6500	16.2000	1.0000

NACA

#Airfoil definition

2312

CONTROL

#label	gain	Xhinge	Xhvec	Yhvec	Zhvec	SgnDup
LeftAileron	0.0000	0.8457	0.0000	0.0000	0.0000	1

#=====Wing section 4=====

SECTION

#Xle	Yle	Zle	Chord	Angle
0.0000	0.0000	0.0000	16.2000	1.0000

NACA

#Airfoil definition

2312

#=====Wing section 5=====

SECTION

#Xle	Yle	Zle	Chord	Angle
0.0000	21.0000	0.6500	16.2000	1.0000

NACA

#Airfoil definition

2312

CONTROL

#label	gain	Xhinge	Xhvec	Yhvec	Zhvec	SgnDup
RightAileron	0.0000	0.8457	0.0000	0.0000	0.0000	1

```

#=====Wing section 6=====
SECTION
#Xle      Yle      Zle      Chord   Angle
  0.0000   46.0000  1.4000   11.0000  1.0000

NACA
#Airfoil definition
  2312

CONTROL
#label      gain      Xhinge   Xhvec    Yhvec    Zhvec    SgnDup
RightAileron 0.0000   0.7727   0.0000   0.0000   0.0000   1

#=====Wing section 7=====
SECTION
#Xle      Yle      Zle      Chord   Angle
  1.8000   55.2000  1.7000   5.2000  1.0000

NACA
#Airfoil definition
  2312

#*****
# Bodies
#*****

#=====Rascal=====
BODY
Rascal
#Nbody     Bspace
  40        1.5000

SCALE
#sX        sY        sZ
  1.0000   1.0000   1.0000

TRANSLATE
#dX        dY        dZ
 -20.0000  0.0000   0.0000

BFILE
#Body file
  Rascal.dat

```

LIST OF REFERENCES

- [1] O. A. Yakimenko, V. N. Dobrokhodov, I. I. Kaminer, K. D. Jones, "Rapid flight test prototyping system for unmanned air vehicles," Book Chapter, Unpublish, 2008.
- [2] I. Desktop Aeronautics, LinAir 4, A Nonplanar, Multiple Lifting Surface Aerodynamics Program, 2003.
- [3] O.A. Yakimenko, Remote Piloted Testbed P-10B Modeling, 2008.
- [4] Wikipedia contributors, (2008, 6 October 2008). Clark Y, 2008, Last Accessed on November 2008.
- [5] B. J. Thomas. The drag coefficient. 2008(September 28).
- [6] M. S. Rice, Handbook of Airfoil Sections for Light Aircraft. USA: Aviation Publications, 1971, p. 143.
- [7] Malcolm Whapshott, "Weathercock Stability," vol. 2008,
- [8] Center for Autonomous Unmanned Vehicle Research, NPS. (2008, Center for autonomous unmanned vehicle research. [Powerpoint File], 2008.
- [9] Anonymous (2004, 03/29/2004). NACA wing section. 2008(11/12), Available: <http://www.ds-cats.com/~kurisawa/aeronautics/Airfoils/01-0027.html>, Last accessed on November 2008
- [10] I. H. Abbott and A. E. von Doenhoff, Theory of Wing Sections Including a Summary of Airfoil Data. ,Corrected with a new pref. by the authors ed.New York: Dover Publications, 1959, p. 693.

THIS PAGE INTENTIONALLY LEFT BLANK

INITIAL DISTRIBUTION LIST

1. Defense Technical Information Center
Ft. Belvoir, Virginia
2. Dudley Knox Library
Naval Postgraduate School
Monterey, California
3. Professor Yeo Tat Soon, Director
Temasek Defence Systems Institute
National University of Singapore
Singapore
4. Tan Lai Poh (Ms), Assistant Manager
Temasek Defence Systems Institute
National University of Singapore
Singapore